

Santa Rosa Swim Meet

Computer Documentation

Neptunes, High School North Bay League, Junior College and Masters

Updated 5/2/2023 by Chris Jones et. al (707)799-5502 cell

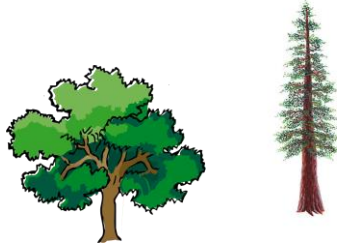

North Bay League



SANTA ROSA JUNIOR COLLEGE



This page intentionally left blank so page 1 can go in the binder sleeve.

Contents

1. Table of Figures	7
2. Table of Tables	8
3. Before Each Meet	9
3.1 Update Software and Licenses	9
Windows	9
Timing System	9
Meet Manager	9
Gadwin Printscreen	10
3.2 Set Up Meet Database.....	11
Create New Database File	12
Edit Meet Setup	12
Add Events	13
Create Sessions	14
Configure Seeding Preferences	15
Configure Report Preferences	15
Configure Entry/Scoring Preferences	16
Configure Scoring Setup	16
Set Entry Fees	17
Update Time Standards.....	17
Add Qualifying Times	20
Update Records	20
Back Up Database File	20
3.3 Solicit Entries	21
Create EV3 File	21
Email EV3 File	21
Set Up Meet in ClubAssistant.....	21
Set Up Meet in FastSwims.....	21
Upload EV3 File to Swim Connection	22
3.4 Force Close Meet Entries	25
3.5 Import Entries	26
From Team Manager	26
From ClubAssistant	26
From SwimConnection	26
From FastSwims	27
Manual Entries	28
3.6 Create Entry Reports	29
Exceptions Report	29
Entry Time Conversion	29
Registration Verification for LSC	29
Meet Psych Sheets	30
Team Psych Sheets.....	32
Meet Program	32

Meet Timeline	33
Meet Warm-Up Report	35
Number of Athletes.....	36
Email Reports	36
Back Up Database File.....	36
Return Mail-in Entries and Checks to Meet Director	36
3.7 Address Registration Problems	37
Edit Athlete Information	37
Back Up Database File	37
Print Discrepancy Reports for Clerk of Course	38
3.8 Post Volunteer Signups.....	40
Timing System Operators	40
Computer Operators	40
Runners	40
3.9 Replenish Office Supplies	41
4. At Each Meet.....	42
4.1 Set Up Computer Equipment	42
Equipment List.....	43
Set Up Computer Room	44
Make Electrical Connections	45
Turn On Equipment.....	47
Configure Network.....	47
Network Troubleshooting	49
Configure Timing Equipment Interface	50
Configure Alphanumeric Scoreboard	50
Configure Serial Port	51
Set Up Meet Mobile	52
4.2 Before Each Session.....	53
Download Session Event List in to Timing System	53
Create Check-in Sheets	53
Create Scratch Sheets	55
Create Session Timeline	57
Create Session Program	59
Create Pre-Seeded Session Program.....	61
Create Consolidated Results of Previous Session.....	63
Create Session Warmup Report	65
4.3 Seeding.....	66
Enter Relay Teams.....	66
Scratch Athletes	67
Seed The Event.....	67
Create Start List File	67
Create Event Program	68
Create Heat and Lane Sheets	70
Create Lane Timer Sheets	72
Create Relay Cards	73

Distribute Seeding Reports	75
Store Scratch Sheets.....	75
4.4 Event Results	76
Move Swimmers.....	76
Move Relay Teams	76
Get Times	77
Verify Times Imported Correctly	77
Verify Primary and Backup Times Agree	77
Enter DQs	77
Edit Times.....	78
Resolve Split and Backup Discrepancies.....	78
List Preliminary Results	78
Score Final Results.....	80
Schedule Swim-offs	81
Obtain Event Packet Approval	81
Correct Results if Needed.....	81
Distribute Approved Results Reports	82
Create Award Labels	82
Prepare Results for Runner	83
Create Swim-off Events.....	83
Create Split-off Events.....	86
Assemble and Store Event Packet	87
Publish results on Meet Mobile	87
Print Corrected Results	87
Create Team Score Report	88
Create Individual Points Report	90
Create Masters 50 Free Challenge Report	91
4.5 Runner Duties	95
Distribute Deck Seeding Reports.....	95
Collect Lane Timer Sheets	97
Carry Event Packet Between Admin and Computer Room	99
Distribute Event Results Reports.....	101
5. After Each Session.....	103
Back up database	103
6. After Each Meet.....	104
6.1 Create Meet Result Files.....	104
CL2.....	104
HTML	105
Full Results PDF	107
Top 5 Results PDF	107
Financial report PDF for Pacific Swimming	108
Financial report PDF for Pacific Masters	109
ZIP.....	109
6.2 Distribute Results.....	110
Email Full Results.....	110
Email Top 5 Results to Newspaper.....	110

Email Results to Pacific Swimming LSC.....	110
Email Results to Pacific Masters.....	110
Email High School Results to Pacific Swimming	110
Email Reports to Meet Director	111
Postal Mail Results to Pacific Masters.....	111
7. Appendix	112
7.1 New Computer Setup	112
Computer Software Installation	112
Share Folders.....	114
Dolphin Firmware Update	114
7.2 Troubleshooting Guide	115
Network Problems	115
Printer Problems	116
Meet Manager Problems	116
7.3 Seeding Checklist	119
7.4 Results Checklist	121

1. Table of Figures

Figure 1: Example time standards report (missing Far Westerns).....	19
Figure 2: Example psych sheet.....	31
Figure 3: Example meet timeline.	34
Figure 4: Example meet warm-up report.....	35
Figure 5: Example name, registration number and LSC discrepancy report.	37
Figure 6: Example team affiliation discrepancy report.....	38
Figure 7: Example unpaid registration report.....	39
Figure 8: Computer room layout.	44
Figure 9: Computer room electrical connection diagram.....	45
Figure 10: Example check-in sheet.	54
Figure 11: Example scratch sheet.	56
Figure 12: Example session timeline.....	58
Figure 13: Example unseeded preliminary session program.....	60
Figure 14: Example preseeded finals meet program.....	62
Figure 15: Example consolidated results report.	64
Figure 16: Example relay entry card.	66
Figure 17: Example event program.....	69
Figure 18: Example heat and lane sheet.....	71
Figure 19: Example lane timer sheet.	72
Figure 20: Example relay cards.	74
Figure 21: Example preliminary results report.	79
Figure 22: Example final results report.....	81
Figure 23: Example award labels.	83
Figure 24: example tie for 10th place requiring a swim-off.	84
Figure 25: Example team score report.....	89
Figure 26: Runner deck seeding delivery diagram.....	96
Figure 27: Runner lane timer sheet delivery diagram.	98
Figure 28: Runner event packet delivery diagram.....	100
Figure 29: Runner results delivery diagram.	102
Figure 30: Example HTML meet results report.....	106
Figure 31: Example financial report.....	108

2. Table of Tables

Table 1: Meet Manager licenses 9

Table 2: Types of meets. 11

Table 3: Office supply list. 41

Table 4: Computer room equipment list. 43

Table 5: Computer room electrical connection list..... 46

3. Before Each Meet

Done by Meet Director.

3.1 Update Software and Licenses

Windows

Turn on all laptops, connect them to the internet, leave them on for hours and let them update Windows automatically. This avoids having the computers trying to update during a meet, which could cause laggy behavior that is especially disruptive to the timing system computer.

Timing System

Check to see if there are updates to the Omega or Dolphin software.

Meet Manager

Make sure you have a Hy-Tek Meet Manager for Swimming license that meets all of your needs and has not expired. Renewing a license can take at least one day, so don't wait until the day of the meet to do this. Here are the licenses needed:

License:	<u>Network</u>	<u>Alpha Scoreboard Interface</u>	<u>Timing Console Interface</u>	<u>Ribbon Labels</u>	<u>Entry Cards/labels</u>
Use	Deck seeding	Names on JC scoreboard	Omega, Dolphin, System 6	Name, stroke and time on back of ribbon	Relay cards
Price on 12/3/2022	\$495	\$495	\$295	\$149	\$99
Needed: Neptunes	yes	Yes, when at JC pool	yes	yes	Yes, for Zone 3 Winter Championships
High School	no	yes	yes	yes	yes
SRJC	no	yes	yes	no	yes
Masters	no	yes	yes	no	yes

Table 1: Meet Manager licenses.

We use three types of licenses:

- SRJC site license, for all meets hosted at the JC except for Neptune Zone 3 championships
- Meet-specific championship license for Zone 3 Winter Championships, provided by Pacific Swimming
- Neptune's club license, for meets hosted at other pools such as Ridgway or Finley

After you buy or renew a license online at the Hy-Tek store, you eventually get an email that confirms that your license is ready for download. To update Meet Manager software and license:

- Launch Meet Manage.
- Click Manage Licenses
- Download new or updated license, or switch license to the one you need to use for this meet

Gadwin Printscreen

Used with Dolphin only.

Check to see if there is an update.

3.2 Set Up Meet Database

The following types of meets are covered in this manual:

	Example no.:	1	2	3	4	5	6	7
	Example meet:	<u>Neptune CBA</u>	<u>Neptune Invitational</u>	<u>Neptune Super League</u>	<u>High School League Champs</u>	<u>SRJC Tri Meet</u>	<u>SRJC Nor Cal Relays</u>	<u>Masters Resolution</u>
Class	Age Group	Yes	Yes					
	Senior/ Open			Yes				
	High School				Yes			
	College					Yes	Yes	
	Masters							Yes
Type	Time Standard	Yes						
	Division by Event				Yes			
	Standard		Yes	Yes		Yes	Yes	Yes
Style	3+ Team Dual Dbl.					Yes		
	Standard	Yes	Yes	Yes	Yes		Yes	Yes
Scoring	Individual		Yes					Yes
	Team			Yes	Yes	Yes	Yes	
Qualifying Times			Yes					
Trials and Finals			Yes		Yes			
Entry Fees	Per athlete	Yes	Yes					Yes
	Per team			Yes	Yes	Yes	Yes	

Table 2: Types of meets.

Create New Database File

Create a folder for this meet under c:\swmeets8\. Include the year, host, meet name and meet type, such as “2022 Neptune Dickens CBA”.

- Put the meet sheet file in it
- If you are creating a meet based on the previous year’s meet, copy the old meet file in to the folder and then rename it with the present year

Start Meet Manager and select File, Open / New.

To edit an existing meet file from a previous year:

- Browse to and open file
- Remove previous entries by:
 - File, Purge
 - Remove data selectively
 - Select Entries/Results, Athletes
 - OK
- Remove previous swim-off and split-off events, if applicable
 - Events
 - Delete all swim-off and split-off events

For a new meet that is not based on a previous year’s meet:

- Browse to the new folder
- Name file with year, host and name of meet
- Click OK

Edit Meet Setup

Go to Setup, Meet Setup.

- Fill in Meet Name, such as “2022 Neptune Dickens CBA”
- Fill in Facility Name, Address, City, State and Postal Code, such as:
 - Santa Rosa Junior College Quinn Aquatic Center, 1501 Mendocino Ave., Santa Rosa CA 95401
 - Ridgway Swim Center, 455 Ridgway Ave., Santa Rosa, CA 95401
 - Finley Aquatic Center, 2060 W. College Ave., Santa Rosa, CA 95401
- Fill in Dates:
 - Start of meet
 - End, of meet
 - Age-up date: in eligibility section of meet sheet, usually the first day of the meet
 - Entry open
 - Entry deadline
- Set other parameters:
 - ID Format = USAS
 - Set Host LSC = PC
 - Base Country = USA

- Altitude in feet – n/a for time adjustments in Bay Area, but here are the altitudes anyway:
 - Santa Rosa Junior College 155'
 - Ridgway 155'
 - Finley 117'
- Class: see table above
- Meet Type: see table above
 - Note: if Time Standards is picked for an open meet, all the entries get converted to NT. But when you switch it back to standard, it asks you to reconvert to yards or meters, and it fixes the problem.
- Meet Style: see table above
- Course: see meet sheet, usually Yards
- DQ Codes = Custom DQ Codes
- Time Adjustment Method = FINA rules
- Click OK

Add Events

If you are editing a previous meet file that has been purged and need to make global changes to all events such as number of lanes, entry fees and fast-to-slow/slow-to-fast, make those changes under Setup Options.

Create the events by clicking on Events tab, then click Add.

First set parameters that will apply to all events:

- Enter first event number, typically 1
- Select Alt Gender, to automatically switch back and forth girls to boys
- Select Gender = Girls, or Women for senior meets
- Round 1:
 - Lanes, i.e. 7 or 8; ask ref if only a max number of lanes is given
 - Enter number of lanes for best number of heats and then select it, i.e. 7 or 8 and 1
 - Assign lanes = standard
 - Event "Entry fee"; in Entry Fee section, i.e. \$4. (Not to be confused with meet participation fee charged once per swimmer per meet, also listed in the same section.)
 - Event Type = Standard
 - Select Pads at Both Ends if applicable, and not already selected per the meet setup section above
- Round 2 or Round 3, if applicable
 - Number of lanes, i.e. 7 or 8
 - Heats in finals, i.e. 1, or 2 for consolations

Then for each gender-paired set of individual events that occur in sequential order:

- Select whether it is an Individual or Relay event
- If boys and girls are mixed, select Mixed. Otherwise make sure gender is correct.
- Select Age Group, or for custom, enter i.e.13 in left box and 109 in the right box for 13 and over
- Select Distance, i.e. 200 for 200 yards
- Select Stroke, i.e. Freestyle

- Select Rounds = Timed Finals, or Prelims and Finals.
- Round 1 Heat order = typically fast to slow for all races; in Rules section; has been slow to fast for Masters
- If event is only 2 years wide, make sure Multi-Age Group is not selected. But if the event is wider than 2 years, split up the event in to 2 year intervals by clicking on the box to the right of Multi-Age Group. This brings up a dialog box that allows you to split up the age groups; press US 5 year to get it split up. For example:
 - 8 and under: 0-6, 7-8
 - 9-12: 9-10, 11-12
 - 11 and over: 11-12, 13-14, 15-16, 17-18, 19-109
 - 13 and over: 13-14, 15-16, 17-18, 19-109
 - Open: 0-6, 7-8, 9-10, 11-12, 13-14, 15-16, 17-18, 19-109

This can be time consuming, so instead of entering events sequentially, enter all events with the same multi-age breakdown, then go back and enter the next set of events with a different age breakdown, etc, instead of switching back and forth every two events.

- Check Meet Sheet to determine whether to select Score Event; typically all are scored.
- Round 2 or Round 3 Finals heat order, if applicable: typically fast to slow; in Rules section.
- If meet sheet states that there are multi-age super finals, such as for the Neptune Invitational:
 - Round 2 or Round 3 – Finals
 - Check box Multi-Age Super Final
 - If High School Meet, select JV or Varsity for Division
- If events are not in sequential order, edit the event number
- If skipping a girls or boys event:
 - Edit event number
 - Select Gender
 - Do not click OK the second time
- Click OK to save girls event, which then preloads the next event number as a boys event
- Click OK to save boys event
- After last event is added, click Cancel to get out of the event creation loop

Then compare entire list of events with meet sheet to insure there are not any errors.

Create Sessions

Go to Events, Sessions and click Add.

For each session:

- Enter Session Number = 1, 2, etc.
- Enter Name = i.e. Saturday, or Saturday AM
- Enter Day = 1, 2, etc
- Enter Start Time; in meet sheet Time section
- Enter Interval = whatever head referee wants, typically 30 sec prelims/timed finals, 45 sec finals to announce names
- Extra backstroke interval = whatever the head referee wants, typically +15 seconds
- Course = yards, or SCM or LCM
- Max entries for meet events export to TM:

- Max entries including relays; in Rules section, typically 4 + number of relays
- Max individual entries; in Rules section, typically 4
- Max relay entries; in Rules section, typically the number of relays
- Click OK. This preloads the next session. Edit title, re-enter max entries, and edit day if applicable
- Click Cancel to exit session adding loop

Add events to each session:

- Select the session
- Double-click on each event to add

Enter any breaks on the meet sheet, in number of minutes, that will occur after events prescribed by the head referee, such as 5 minutes before and 5 minutes after a block of 25s where timers need to move to the other end of the pool, or other breaks during a long meet.

If any two events are to alternate boys and girls, enter the event number to alternate within the Alt column, and the other event will be auto-filled with the correct event to alternate with.

Close Session window.

Close Events window.

Configure Seeding Preferences

For trials and finals and Masters meets only. See table above for details.

Go to Setup, Seeding Preferences.

For trials and finals meets:

- Enter number of prelim heats to be circle seeded if applicable, typically 3
- Enter final seeding, typically standard, but could be circle seeding for championship meets

For Masters meets that typically use lanes 2-7 out of 8:

- Click on Standard Lanes tab
- Click Lane Preferences for Seeding
- In 6 lane column, enter "453627"; will not assign lanes 1 and 8
- Click OK

Configure Report Preferences

For time standard meets only.

- Select Setup, Report Preferences
- Select Report Formats tab
- Select Flag Over-achievers with a "+" (This is someone who enters with one level such as "C" whose results are at an increased level such as a "B".)

Configure Entry/Scoring Preferences

For scoring and time standard meets only. Select Setup, Entry / Scoring Preferences.

For scoring meets, click Scoring Awards tab:

- Enter maximum scorers per team per event for individual and relays, if noted in Scoring section of meet sheet such as high school league championships.
- Top how many for award labels, if awards are to be given per Awards section of meet sheet; fill in individual and relay from meet sheet Awards section, i.e. 7 and 7; may not print all during meet, such as for 13 and over, or may not have any awards, a.k.a. ribbons
- Entry Limits tab
 - Maximum entries per athlete including relays for all days of the meet; see meet sheet
 - Maximum individual entries per athlete for all days of the meet; see meet sheet
 - Maximum relay entries per athlete for all days of the meet; see meet sheet

For time standards meet click Time Stds Meet Tab:

- Select points awarded based on Seed Time
- Select Points and awards given to Over achievers, i.e. if a B swimmer gets an A time
- Select Points and awards given to Under achievers, i.e. if an A swimmer gets a B time

Click OK to exit Entry / Scoring Preferences.

Configure Scoring Setup

For scoring meets only. See table above for details.

Select Setup, Scoring Setup, Standard or Alternative:

Compare standard scoring to meet sheet Scoring section. If different, select Alternative and edit individual and relay points vs. place per meet sheet.

For SRJC Norcal relays only where the scoring is different than just individual and relay – there are 2-, 3- and 4-person relays with different scoring:

- Set up as a time standard meet – Setup, Meet Setup, Meet Type = Standard.
- Go to Events, Standards
 - Create divisions such as EXH/2REL/3REL/4REL for exhibition and 2/3/4-person relays, respectively
 - Create impossible 4REL time standards for 3REL and 2REL events, and impossible 3REL times for 2REL events. This forces everyone in to the desired time standard.
- In Entry/Scoring Preferences Scoring/Awards tab select “Different point system for each division”
- Go to Scoring Setup, Standard and edit the scoring for each division to match the meet sheet
- To score diving 2RELS, in Run use JD to adjust scores. This is an acceptable workaround since there are usually not too many divers.

Click OK to exit Scoring Setup section.

Set Entry Fees

For meets with entry fees. See table above for details.

Select Setup, Entry Fee Surcharges

- Type Athlete Surcharge in box, i.e. \$8
- Type Team Surcharge in box, i.e. \$400.
- Click X

Update Time Standards

For time standard meets only.

Get standards from Pacific Swimming web site www.pacswim.org

- Click Times, Time Standards.
- Click [year range] USA-S Motivational Standards for Hy-Tek Meet Manager and download STD file to meet database folder.
- Click 8 and Under Time Standards and download PDF file to meet database folder.
- Click [year range] PC Junior Olympics Time Standards and download PDF file to meet database folder.
 - (Hopefully an STD/ST2 file will be posted for JOs and FWs to download in the near future.)
- Extract USA-S STD file from ZIP file using Windows Explorer.
- Copy STD file to meet folder.

Import or enter time standards in Meet Manager

- Go to Events, Standards
- If you are updating any time standards from the previous year, delete the time standards first in the Tag box in the lower left corner by selecting them and then clicking the X
- Click Import
- For USA-S motivational standards:
 - Browse to unzipped USA-S STD file and double click on it
 - Double-click on AAAA time and verify it adds a column and updates it
 - Repeat the process for AAA, AA, A, BB and B
- If there are any time standards that don't match up exactly, such as a 9-10 event that needs the 10 and under standard:
 - Select Custom Age Groups
 - Enter for Use this age group's time standards, i.e. 0 and 10
 - Enter For, i.e. 9 and 10
 - Click OK

Manually edit time standards

- For PC 8 and under time standards:
 - Browse to unzipped PC 8 and under time standard PDFs and open them.

- Manually enter A and B times in to 6 and under, then copy down to 7-8. Leave the rest of the 6 and under and 7-8 columns blank, such as AA, AAA, etc.
- For JOs:
 - Click on white paper icon to add tag, and name it “JO”
 - Browse to JO time standard PDF and open it
 - Manually enter times in to all age groups:
 - 10 and under in to 0-6, 7-8 and 9-10
 - 11-12 in to 11-12
 - 13-14 in to 13-14
 - 15-18 in to 15-16 and 17-18
- For C: click on white paper icon to add tag, and name it “C”.
- Leave standards blank for 19 and over, since none apply to them.

Set up time standards for reports and scoring

- For CBA meets:
 - In Standards column, Select B and A only, the times that will show up on the report.
 - In Scoring column, select C, B and A only, the standards that will be used for awards.

Export time standards for next meet

- Click Export, Yes

Import time standards from previous meet

- Click File Import, Time Standards
- Click Import
- Double-click on AAAA time and verify it adds a column and updates it
- Repeat the process for AAA, AA, A, BB, B and JO
- If there are any time standards that don't match up exactly, such as a 9-10 event that needs the 10 and under standard:
 - Select Custom Age Groups
 - Enter for Use this age group's time standards, i.e. 0 and 10
 - Enter For, i.e. 9 and 10
 - Click OK.

Note: if an event/age group wasn't swum in the earlier meet, the time standard doesn't come over, so you might want to create a dummy meet file to export with all the events.

- Click on white paper icon to add tag, and name it “C”.

Select time standards

- Select B, A and AA Time Standards so they show up in the Meet Program at the top of each event, and after each swimmer's time in Results, except for C and special minimum standards such as “MIN” made up just for the meet.
- See which standards are used for scoring per the Awards section in the meet sheet, and select them. Typically C, B and A only for C/B/A meets; do not select BB, AA, AAA, AAAA, JO or FW.

If there are any questions from officials about the time standards entered for a meet, create a report, save as PDF, and send to officials. Note that some event age subgroups do not have all standards, which is consistent with what is posted in the standards PDFs. Make sure the time standards report looks like this:

2014 Swim Like the Dickens - 12/12/2014 to 12/14/2014

Time Standards Report

Event	AAAA	AAA	AA	A	BB	B	C	JO	MIN
Event 1 Girls 11-12 400 IM	4:51.49	5:05.29	5:19.19	5:33.09	6:00.89	6:28.59		5:27.49	5:33.09
Event 1 Girls 13-14 400 IM	4:36.39	4:49.59	5:02.69	5:15.89	5:42.19	6:08.49		5:09.49	5:33.09
Event 1 Girls 15-16 400 IM	4:28.89	4:41.69	4:54.49	5:07.29	5:32.89	5:58.49		5:09.49	5:33.09
Event 1 Girls 17-18 400 IM	4:26.89	4:39.59	4:52.29	5:04.99	5:30.39	5:55.79		5:09.49	5:33.09
Event 1 Girls 19&O 400 IM									5:33.09
Event 2 Boys 11-12 400 IM	4:45.09	4:58.69	5:12.19	5:25.79	5:52.99	6:20.09		5:27.99	5:25.79
Event 2 Boys 13-14 400 IM	4:18.69	4:31.09	4:43.39	4:55.69	5:20.29	5:44.99		4:54.99	5:25.79
Event 2 Boys 15-16 400 IM	4:08.49	4:20.39	4:32.19	4:43.99	5:07.69	5:31.39		4:54.99	5:25.79
Event 2 Boys 17-18 400 IM	4:02.59	4:14.19	4:25.69	4:37.29	5:00.39	5:23.49		4:54.99	5:25.79
Event 2 Boys 19&O 400 IM									5:25.79
Event 3 Girls 11-12 500 Free	5:21.99	5:37.29	5:52.59	6:07.99	6:38.59	7:09.29		5:54.99	6:37.99
Event 3 Girls 13-14 500 Free	5:08.79	5:23.49	5:38.29	5:52.99	6:22.39	6:51.79		5:35.99	6:37.99
Event 3 Girls 15-16 500 Free	5:00.99	5:15.39	5:29.69	5:43.99	6:12.69	6:41.29		5:35.99	6:37.99
Event 3 Girls 17-18 500 Free	4:59.59	5:13.79	5:28.09	5:42.29	6:10.89	6:39.39		5:35.99	6:37.99
Event 3 Girls 19&O 500 Free									6:37.99
Event 4 Boys 11-12 500 Free	5:17.29	5:32.39	5:47.49	6:02.59	6:32.79	7:02.99		5:52.99	6:02.59
Event 4 Boys 13-14 500 Free	4:52.09	5:05.99	5:19.99	5:33.89	6:01.69	6:29.49		5:25.29	6:02.59
Event 4 Boys 15-16 500 Free	4:40.99	4:54.39	5:07.79	5:21.19	5:47.89	6:14.69		5:21.49	6:02.59
Event 4 Boys 17-18 500 Free	4:36.19	4:49.39	5:02.49	5:15.69	5:41.99	6:08.29		5:21.49	6:02.59
Event 4 Boys 19&O 500 Free									6:02.59
Event 5 Girls 13-14 200 Back	2:06.29	2:12.29	2:18.29	2:24.29	2:36.29	2:48.39		2:23.89	
Event 5 Girls 15-16 200 Back	2:03.59	2:09.49	2:15.29	2:21.19	2:32.99	2:44.79		2:23.89	
Event 5 Girls 17-18 200 Back	2:01.99	2:07.79	2:13.59	2:19.39	2:30.99	2:42.59		2:23.89	
Event 6 Boys 13-14 200 Back	1:58.79	2:04.49	2:10.09	2:15.79	2:27.09	2:38.39		2:25.59	
Event 6 Boys 15-16 200 Back	1:53.69	1:59.09	2:04.49	2:09.89	2:20.69	2:31.59		2:24.49	
Event 6 Boys 17-18 200 Back	1:50.59	1:55.79	2:01.09	2:06.29	2:16.89	2:27.39		2:24.49	
Event 7 Girls 9-10 100 Back	1:10.09	1:13.99	1:17.89	1:21.79	1:33.49	1:45.09		1:23.39	
Event 8 Boys 9-10 100 Back	1:09.49	1:13.09	1:16.59	1:20.09	1:30.79	1:41.39		1:24.99	
Event 9 Girls 6&U 25 Back				23.49		28.49			
Event 9 Girls 7-8 25 Back				23.49		28.49			
Event 10 Boys 6&U 25 Back				23.49		28.49			
Event 10 Boys 7-8 25 Back				23.49		28.49			
Event 11 Girls 13-14 100 Free	53.59	56.09	58.69	1:01.19	1:06.29	1:11.39		58.09	
Event 11 Girls 15-16 100 Free	52.49	54.99	57.49	59.99	1:04.99	1:09.99		58.09	
Event 11 Girls 17-18 100 Free	52.09	54.49	56.99	59.49	1:04.49	1:09.39		58.09	
Event 12 Boys 13-14 100 Free	49.79	52.09	54.49	56.89	1:01.59	1:06.29		55.29	
Event 12 Boys 15-16 100 Free	47.49	49.69	51.99	54.19	58.69	1:03.29		52.99	
Event 12 Boys 17-18 100 Free	46.59	48.79	50.99	53.19	57.69	1:02.09		52.99	
Event 13 Girls 9-10 50 Fly	30.99	32.89	34.79	36.69	42.39	47.99		36.99	
Event 14 Boys 9-10 50 Fly	30.89	32.69	34.39	36.19	41.39	46.69		37.29	
Event 15 Girls 6&U 25 Fly				22.59		27.39			
Event 15 Girls 7-8 25 Fly				22.59		27.39			
Event 16 Boys 6&U 25 Fly				22.59		27.39			
Event 16 Boys 7-8 25 Fly				22.59		27.39			
Event 17 Girls 11-12 100 Back	1:02.49	1:05.89	1:09.29	1:12.69	1:19.49	1:26.29		1:11.49	
Event 18 Boys 11-12 100 Back	1:00.89	1:04.19	1:07.49	1:10.79	1:17.49	1:24.09		1:12.89	
Event 19 Girls 13-14 100 Breast	1:07.09	1:10.29	1:13.49	1:16.59	1:22.99	1:29.39		1:15.99	

Figure 1: Example time standards report (missing Far Westerns).

Add Qualifying Times

Check the meet sheet for any events with qualifying times. For instance, the open 500 free may have different slowest times for girls and boys listed in the event table. If so, then:

- If the time standard does not line up with an existing standard across all age groups within an event, click on white paper icon to add tag, and call it “MIN” and click “OK”. A new column appears in the event table.
- Now type the time standards in to the new column table that aligns with the row for each event.
- Click Custom Qual Times box. Two new columns appear.
- In the new Equals or Faster column, select the correct time standard for each even that has one, i.e. “MIN”, or “A” for long events or Zones.
- Click X to exit Time Standards.
- Click X to exit Events.

Update Records

For high school championships and Masters, update records each year. Similar to time standards, except in events click Records tab and fill in manually. Get records from governing bodies i.e. NBL or Pacific Masters for Pacific Masters, US Masters Swimming, and World Masters records.

Back Up Database File

Exit out of Meet Manager and back up meet file by manually making a copy, appending the name of the file with the timestamp of the backup time and date and “ upload to swim connection”, and place in a backup folder.

3.3 Solicit Entries

Create EV3 File

In Meet Manager:

- Click File, Export, Events for TM
- Make sure information presented is correct; if so click Yes.
- Select multi-cut order YSL for short course yards, and LSY for long course meters
- Make sure Do Not Convert to yards is selected, then Click OK
- Browse to your meet folder to save the file, then click OK and files will be zipped

In Windows Explorer, unzip the new file. The file will be named something like “Meet Events-2014 Neptune Fall Classic-27Sep2014-001.zip”. An EV3 and HYV file should have been created.

Email EV3 File

For small team meets like Super League and JC meets only.

Email the EV3 file as an attachment to the meet director for distribution to participating team coaches who will fill out the entries and return the files.

Set Up Meet in ClubAssistant

For high school and Masters meets only.

Send meet sheet to Club Assistant and they will set it up.

Set Up Meet in FastSwims

Neptune club meets only.

Carlene Takaki is the contact for FastSwims - carlene@fastswims.com

- FastSwims.com
- Create Meet
- On the Meet Set Up Request page - fill in boxes as the meet sheet states
- Submit form
- Carlene takes care of the rest and you will be notified when the meet opens.

Upload EV3 File to Swim Connection

Legacy Neptune club meets only; may not be used again.

Go to the Swim Connection entry web site www.ome.swimconnection.com and log in. Obtain user name and password and Admin privileges.

Create new meet:

- Click My Meets, Add New Meet.
- Select Pacific Swimming as Swimming Association and click Continue.
- Select Load info from a HyTek meet file and click Choose File, or select a previous meet on SwimConnection if there were a lot of custom configurations such as Neptune Invitational.
- Browse to the .EV3 file that was unzipped in the previous section, then click Continue. Meet will load.

Fill out Core tab:

- Click Core tab
- Enter Meet Code = SRN
- Enter Name i.e. SRN Short Course C/B/A+
- Enter Additional Name i.e. Fall Classic
- Enter Host = Neptune Swim Club
- Close date = see meet sheet Online Entries section for date, then enter 11:59 PM for the time of day.
- Select Meet Type = Time Standard for CBA and invitational
- If you have any events that have qualifying times, select Allow Qualifying Times, but select No for
- Allow Bonus Events.
- Enter fee per swimmer, i.e. \$8.00.
- Enter fee per event, i.e. \$4.00.
- Fill in payment information per meet sheet Mailed or Hand Delivered Entries section.
- Verify all other information is correct when compared to the meet sheet.
- Click Choose File under Meet Sheet
- Browse to final sanctioned meet sheet PDF version
- Select Software = Hy-Tek Meet Manager
- If invitational, select Restrict Teams and fill out list of teams invited.
- Click Save.

Fill out Sessions tab:

- Click Sessions Tab. For each session:
- Select session.
- Click Edit.
- Fill in Name, i.e. "Saturday".
- Make sure course selection is correct, i.e. "SCY".
- Fill in note with schedule information, i.e. "Warm ups 7:30AM-8:45AM. Session starts at 9:00 AM."
- Make sure session Max Total Swimmers and Max Total Entries are both blank – might need to delete the latter..
- Make sure max individual entries matches the meet sheet.

- Select Lenient if deck seeding only.
- Save.
- Select session again.
- If most events do not have a time standard, Click NT OK; otherwise Click NT NOT OK.

Fill out Events tab:

- Click Events Tab:
- Make sure all the events uploaded and are correct.
- If there are any events that have time standards but you selected NT OK for the whole session, for each event that needs a time standard:
 - Select Event.
 - Click Edit.
 - Click Show Add Event Details.
 - Select course = SCY
 - Select NT Allowed = No
 - Type in qualifying time, do not fetch it.
 - Select Equal to or Faster.
 - Click Save.
- If there are single year age group entry times such as for the Neptune Invitational, you need to delete events and add one event per age with same event number.
- For single age group invitational, the age groups in each event get combined in to one event with the youngest time standard. So if this is the first time you set up such a meet, you need to change the first event of each session to only the youngest age, delete all subsequent events in the session, then rebuild them with single ages, so event 7 11-14 is now 4 event 7s, 11, 12, 13 and 14. They cannot be reordered, hence the need to redo them. You also need to type in the qualifying time, i.e. USAS single age group BB, in to each of the new sub-events.

Note: we do not know how to enter the qualifying times as of 1/12/2017. Adding new events leaves nowhere to add the qualifying times, even when Allow Qualifying Times has been checked in the Core tab. Only the copied over file from the previous year comes with qualifying times. This will require tech support from SwimConnection if any new events are added, or if any events are reordered. But since we are not using them any more this is a low priority to resolve.

Verify Venues tab:

- Click Venues tab, and make sure everything is correct.

Fill out Constraints tab:

- Click Constraints tab
- Enter Individual Swimmers Cap, from meet sheet
- Swimmers individual entries cap Lenient = Yes
- Click Continue.

Fill out Status tab:

- Click status tab.

- Select Read/Write access for yourself.
- Invite head referee and admin by entering their logins. Get information from head referee.
- Give read/write access to head coach, read only access to admin.

If you have any problems with the meet setup, ask Swim Connection staff for help:

- Click Help hypertext in the upper right hand corner of the Swim Connection web page.
- Click Contact Us.
- Either click their email address hypertext, ome-support@swimconnection.com, or cut and paste the address in to your email browser, and compose an email listing the meet, and the issue you are having.

Test the meet:

- Again under status tab, test the meet by clicking Start Trial. If you need to fix something, go back to this page and click Fix Configuration. You can do this loop as many times as required to get it right.
- Go to Enter Meets, select your trial meet, and do pretend entries of your swimmers to make sure it works. Try entering too many events per session, NT and too high of times for events that don't allow it, and times below, at and above qualifying times to make sure rejections only occur above qualifying times and for teams not invited to invitationals.
- Once done testing, click that you have tested it, which will then invoke Swim Connection to put it out for entries.

3.4 Force Close Meet Entries

For legacy Neptune SwimConnection meets only.

The head referee will monitor the meet and decide if it needs to be closed early. They can force closure on Swim Connection directly, by requesting SwimConnection to do it remotely, or you can do it by:

- Log in to SwimConnection Online Meet Entries.
- Go to My Meets.
- Select meet.
- Go to Configuration.
- Go to Constraints.
- Select Force Close = yes.
- Add close note, such as “12 and under 4 hour rule.”
- Click Save.

3.5 Import Entries

Do one of the following four methods of importing entries in to Meet Manager:

From Team Manager

For small team meets such as Superleague or SRJC tri-meets.

Download HY3 entry files emailed from participating teams:

- Save zipped files in the meet folder.
- Unzip the files.

Import entries in to Meet Manager. For each team:

- File, Import, Merge Entries (MM to MM)
- Browse to the HY3 file
- Click Open
- Click OK
- Note number of athletes and entries, then click OK

From ClubAssistant

For high school championships and Masters meets only.

Download SD3 file from ClubAssistant:

- Go to www.clubassistant.com.
- Go to Client Login, Meet Administrators.
- Log in – you need to be set up with user name and password for this meet.
- Select Swim Competitions, All.
- Select meet.
- Select Reports, Individual Entries.
- Scroll to bottom and select Submit under Individual Entries SD3 file.
- Re-scroll down to the bottom and click on Download Individual Entries SD3 File next to Option 2. This downloads the SD3 file to your Downloads folder. Note that if this doesn't work, download HY3 file instead.
- Copy SD3 file from downloads in to meet folder.
- Log out of ClubAssistant.

Import Entries:

- Import SD3 file in to Meet Manager as described above under From SwimConnection.

From SwimConnection

For Neptune club meets only, may not be used again.

Download SDIF entry file and T-shirt CSV file from Swim Connection:

- Log in to Swim Connection Online Meet Entries.
- Go to My Meets, and select meet.
- Select Reports.
- Select Generate and Email SDIF file for Computer Operator at meet.
- Select Report Output = Email, enter your email address, and click Generate Report and OK to confirm.
- Select Reports.
- Select Generate and Email CSV for T-shirt vendor.
- Select Report Output = Email, enter your email address, and click Generate Report and OK to confirm.
- Check email and save the reports to your computer.
- Unzip the SDIF report.

Import SD3 file in to Meet Manager:

- File, Import, Entries.
- Browse to sd3 file you just unzipped.
 - For some reason you will need internet connection while you do this – not sure why.
 - Note that you need to have Meet Manager running in Windows 8 compatibility mode – not sure why:
 - Right-click Meet Manager icon and select Properties
 - Select Compatibility tab
 - Select Run in Compatibility Mode
 - Select Windows 8
 - OK
- Failure to do this will force you to update to a new Meet Manager version. It may work to install it in Windows 8 compatibility mode but I'm not sure.
- Select Match on Event Numbers and Include Entries with No Time, but nothing else, including enforcing qual times.
- If there is a team name mismatch exception, select what is already in the database.

From FastSwims

Neptune club meets only.

Carlene sends over everything to the contact listed in the meet set-up request page.

Manual Entries

Sources include postal mail, email, verbal and hand delivery. Also applies to adding non-scoring B-Relays for high school championships. Check with head ref to get permission to add any postal mail post marked after the close date.

Go to Athletes tab. For each athlete:

- Click first letter of last name to and then scroll down to see if athlete is already entered. If already entered, select name and edit which events are selected and their entry times.
- To add athlete
 - Click Add
 - Enter name
 - Enter birth date
 - Verify reg number (Neptune club meets only)
 - Select team name
 - Select gender
 - Select which events they are entered in and enter their entry times. You can skip the colon but all entry times need the period.
- If team not already in database or you notice an error:
 - Click Teams or schools
 - Add/Edit
 - Team Abbreviation, i.e. SRN or UN
 - Full Team name, i.e. Neptune Swimming or Unattached
 - LSC, i.e. PC, SN, CC, OR
 - Click X to exit
 - Click X to exit
- Verify payment is correct, if so, add note to entry form that they are entered and paid, listing check number.
- If Masters, Meet Manager will complain about reg number format: accept anyway.
- Return entries and checks to Meet Director.

3.6 Create Entry Reports

Exceptions Report

This report lists athletes that are entered in too many events if you selected Lenient, as well as too many entries per high school scoring vs. exhibition if you set it up that way for a high school championship.

- Select Reports, Exceptions Report.
- Select all sessions.
- Make sure max swims per session for individual and relays is correct.
- If there are minimum standards to meet, select those standards.
- Create Report.
 - Note: if it says no data selected, click stuff and then try again and then it will work. This seems to be a bug.
- If there is deck seeding, print out and give to Clerk of Course for highlighting checkin sheet to inform if there are any scratch downs required. If pre-seeded, send to head referee ASAP so they can work with the coaches to do scratchdowns before all the sheets are preprinted out.

Note: if two swimmers have the same first and last name, Meet Manager 5 (not sure about newer) merges them and you may not detect that there is now one swimmer with too many events and some of them hidden. Select “Show Swim-Ups” in the athlete view to see this. If you have this problem, add a middle initial or somehow change their name and then in the results email to Pacific Swimming ask them to undo the change.

Entry Time Conversion

Verify all entry times are shown in the converted time column in the Athlete and Relay views. If not, go to File, Setup, Reconvert Entry Times.

Registration Verification for LSC

For club meets only.

Go to Reports, Athlete Rosters.

- Under Report Type, select Detailed, Sorted by Team.
- Deselect Include Athletes with No Events.
- Create Report.
- Select Microsoft print to PDF printer
- Print to it
- Browse to meet folder
- Name it “[meet name] registration verification report”
- Click X to exit

Create SD3:

- File, Export, USA-S Registration.
- Accept default and click OK.
- OK when export finished.
- Browse to swim meet database folder such as c:\users\neptune\documents\meets\20161014 Fall Classic\ and click OK. Autonomes the file such as sdif001.sd3.
- Zip PDF and SD3 files together and name “[meet name]registration verification report.zip”

Email swimmer registration file reg* zip to office-membership@pacswim.org, and cc head referee and admin. This will forward it to the person doing the job, which as of December 2016 is Laurie Benton, Laurie@pacswim.org . Note: the error report will not be sent back until 1-2 days before the meet to make sure the last registrations are picked up. If there are swimmers from other LSCs such as Sierra Nevada, send them a report too. You can filter on LSC when you make the report.

Meet Psych Sheets

For deck seeded Neptune club meets only.

- Select Reports, Psych Sheets.
- Verify the following only are selected:
 - Gender = all
 - Rounds = all rounds
 - Indiv + Relays
- Select all sessions
- Click Select All to select all events
- Select Columns / Format tab and set only:
 - Columns = double
 - Format = nothing selected
 - Athlete ID = none
 - Time stamp = date and time
- Select Include in Psych sheet tab, and select only:
 - Time Standards, if time standards meet such as CBA
 - Entry qualifying times, if applicable
 - Entry Times
 - (deselect line for results)
- Select Filter / Sort Order Options and select only:
 - Filter = none
 - Sort Order = fast to slow
- Create Report. Make sure it looks like this:

Event 1 Girls 11 & Over 400 Yard IM

Name	Age	Team	Seed Time
1 Motekaitis, Mia P	16	UCD-SN	4:38.41 AA
2 Swayne, Sofie K	15	CCA-SN	4:46.02 AA
3 Nowack, Theresa A	17	SRN-PC	4:51.89 AA
4 Leacox, Kyla W	17	UCD-SN	4:52.54 A
5 Kellison, Makayle S	14	SRN-PC	4:54.56 AA
6 Hardey, Ellie G	13	CCA-SN	4:56.69 AA
7 Vogel-Rigler, Verity	16	CCA-SN	4:58.05 A
8 McElhern, Kaitlyn A	14	UCD-SN	5:00.91 AA
9 Perkins, Avery W	14	SRN-PC	5:01.65 AA
10 Strub, Mikaela L	16	CCA-SN	5:05.05 A
11 Morris, Lauren M	15	SRN-PC	5:05.41 A
12 Baumgartner, Nat R	16	MCSO-PC	5:08.86 B
13 Motekaitis, Elle P	15	UCD-SN	5:10.62 B
14 Ansari, Nadia F	14	CCA-SN	5:10.91 A
15 Cameron, Natasha C	16	SD-PC	5:17.53 B
16 Smits, Emma E	14	SRN-PC	5:19.03 B
17 Campbell, Bre A	14	GOLD-SN	5:19.87 B
18 Stewart, Brydie E	15	SRN-PC	5:20.61 B
19 Gagnon, Anya G	11	SSS-PC	5:28.29 A
20 Hahn, Ashleigh M	14	UCD-SN	5:30.42 B
21 Burke, Emi C	12	SRN-PC	5:32.59 A
22 Holzhauser, Stassi J	12	SRN-PC	5:37.93 B
23 Morris, Nicole M	13	SRN-PC	5:42.17 B
24 Hoffman, Hannah A	12	SRN-PC	5:44.08 B
25 Gwaltney, Madison T	14	CCA-SN	5:44.81 B
26 Waterson, Alyssa N	12	UCD-SN	6:04.04 B
27 Campbell, Peighton G	13	GOLD-SN	6:22.33
28 Glenn, Riley M	13	CCA-SN	6:37.61
29 Clarkson, Stella J	12	SRN-PC	NT
30 Solomon, Talia D	11	YPAC-PC	NT
31 Myler, Kathryn G	11	UCD-SN	NT
32 Leacox, Makena M	11	UCD-SN	NT

Event 2 Boys 11 & Over 400 Yard IM

Name	Age	Team	Seed Time
1 Monks, Ray M	16	SRN-PC	4:21.93 AA
2 Sipple, Drew A	19	SRN-PC	4:22.06
3 Mertz, David W	16	SRN-PC	4:25.79 AA
4 Wong, Connor H	15	SRN-PC	4:33.56 A
5 Jones, Trevor M	16	SRN-PC	4:40.88 A
6 Carter, Will T	14	SRN-PC	4:55.93 B
7 Ignacio, Jonah T	14	CCA-SN	4:59.38 B
8 Jamison, Brady M	14	CCA-SN	5:12.28 B
9 Walker, Mitchel D	15	MCSO-PC	5:27.76 B
10 Bhana, Aiden R	13	SRN-PC	NT

Event 3 Girls 11 & Over 500 Yard Freestyle

Name	Age	Team	Seed Time
1 Motekaitis, Mia P	16	UCD-SN	4:59.87 AA
2 Bristow, Annie L	16	CCA-SN	5:04.91 AA
3 Buell, Sierra N	17	CCA-SN	5:05.52 AA
4 Jones, Megan C	15	SRN-PC	5:10.69 AA
5 Jamison, Taylor C	16	CCA-SN	5:13.68 AA
6 Kwan, Julie M	15	SRN-PC	5:16.10 AA
7 Vogel-Rigler, Verity	16	CCA-SN	5:19.97 AA
8 Swanson, Alina C	14	CCA-SN	5:21.94 AA
9 McElhern, Kaitlyn A	14	UCD-SN	5:27.12 AA
10 Scobey, Taylor S	15	SRN-PC	5:29.58 AA
11 Leacox, Kyla W	17	UCD-SN	5:31.24 A
12 Hardey, Ellie G	13	CCA-SN	5:33.93 AA
13 Moussa, Grace N	15	SRN-PC	5:36.87 A
14 Oliver, Tessa L	15	SRN-PC	5:39.33 A
15 Mattice, Vivien G	13	SRN-PC	5:39.34 A
16 Motekaitis, Elle P	15	UCD-SN	5:39.74 A
17 Smith, Rea N	12	SRN-PC	5:41.30 AA
18 Lewis, Alexis M	11	SRN-PC	5:46.42 AA

Figure 2: Example psych sheet.

Create psych sheet PDF:

- Click printer selection icon
- Select Microsoft print to PDF
- Exit
- Click print icon
- OK
- When prompted, name the file “[name of meet] Preliminary Meet Program”
- Save to swim meet database folder
- OK

Print the psych sheet, if asked to:

- Select printer
- Select double-sided

Team Psych Sheets

For high school championships only.

Before seeding, create individual team psych sheets for coaches to confirm all entries are correct before seeding. To do so:

- Follow the same instructions as Meet Psych Sheets above, except filter on one team at a time when generating the report
- Then send each coach their psych sheet
- Once they confirm entries are correct, then seed the meet and proceed to creating the meet program.

Note: do not share team psych sheets with other teams so they don't get advanced view of the competition and be tempted to restack their relays or individual events.

Meet Program

For preseeded meets such as high school championships. To be done only after individual team psych sheets have been verified. For meet ref, then eventually for meet admin, officials, director, coaches and possible for sale.

Seed meet:

- Select sessions
- Select events
- Start seeding
- Manually seed B relays in to separate heats before A relays

Create meet program

- Reports
- Meet Program
- Select all sessions and events
- Format to 2 columns, no empty lanes, no space for results
- Create report

- Print to PDF

Send to meet ref, director and coaches.

Meet Timeline

Set up timeline parameters:

- Click Events, Sessions
- For each session:
 - Double Click on Session
 - Set Start Time, example 05:00 PM
 - Interval (typically 30 sec prelims/timed finals, 45 sec finals to announce names)
 - Extra backstroke interval (typically +15)
 - OK
- Click X to close
- Click X to close

If head ref asks for prior meet scratch rate for deck seeded meets, open old meet and do the following:

- Reports
- Meet Summary
- Summary Totals
- By Athlete
 - This lists scratch rate, i.e. 469 scratches, 2067 splashes, 18% scratch rate = $469/(469 + 2067)$
- Create report
- Print to PDF
- Send to head ref

Create timeline:

- Reports, Sessions
- Select All to select all sessions
- Include event start times
- Include heat and entry count
- Include *type entries
- Enter scratch factor, as prescribed by head referee; start with 3%
- Create report. Make sure it looks like this:

Neptune Swimming Invitational 14-Under - 2/14/2014 to 2/16/2014

Session Report

Session: 1 Friday February 08, 2013

Day of Meet: 1 Starts at 05:00 PM Heat Interval: 15 Seconds / Back +15 Seconds

Round	Event	Entries	Heats	Starts at
Finals	1 Girls 13 Year Olds 400 IM	16	2u	05:00 PM
Finals	2 Boys 13 Year Olds 400 IM	12	2u	05:11 PM
Finals	3 Girls 14 Year Olds 400 IM	5	1u	05:22 PM
Finals	4 Boys 14 Year Olds 400 IM	6	1u	05:27 PM
Finals	5 Girls 10 & Under 500 Freestyle	10	2u	05:32 PM
Finals	6 Boys 10 & Under 500 Freestyle	4	1u	05:47 PM
Prelims	7 Girls 11-14 500 Freestyle	44	6u	05:53 PM
Prelims	8 Boys 11-14 500 Freestyle	30	4u	06:31 PM
	Swimmer Count for Warm-ups: 121	=====	=====	
	Entry / Heat Totals:	127	19	
	Finish Time			06:56 PM

Session: 2 Saturday February 09, 2013

Day of Meet: 2 Starts at 09:00 AM Heat Interval: 30 Seconds / Back +15 Seconds

Round	Event	Entries	Heats	Starts at
Finals	9 Girls 10 & Under 50 Freestyle	25	4u	09:00 AM
Finals	10 Boys 10 & Under 50 Freestyle	9	2u	09:05 AM
Prelims	11 Girls 11-14 50 Freestyle	79	10u	09:07 AM
Prelims	12 Boys 11-14 50 Freestyle	54	7u	09:16 AM
Finals	13 Girls 10 & Under 100 Backstroke	16	2u	09:23 AM
Finals	14 Boys 10 & Under 100 Backstroke	6	1u	09:27 AM
Prelims	15 Girls 11-14 100 Backstroke	66	9u	09:29 AM
Prelims	16 Boys 11-14 100 Backstroke	52	7u	09:47 AM
Finals	17 Girls 10 & Under 50 Butterfly	23	3u	10:00 AM
Finals	18 Boys 10 & Under 50 Butterfly	4	1u	10:04 AM
Prelims	19 Girls 11-12 50 Butterfly	26	4u	10:05 AM
Prelims	20 Boys 11-12 50 Butterfly	24	3u	10:09 AM
Prelims	21 Girls 13-14 200 Butterfly	19	3u	10:12 AM
Prelims	22 Boys 13-14 200 Butterfly	10	2u	10:21 AM
Finals	23 Girls 10 & Under 100 Breaststroke	20	3u	10:26 AM
Finals	24 Boys 10 & Under 100 Breaststroke	5	1u	10:32 AM
Prelims	25 Girls 11-14 100 Breaststroke	47	6u	10:35 AM
Prelims	26 Boys 11-14 100 Breaststroke	27	4u	10:45 AM
Prelims	27 Girls 11-14 200 IM	68	9u	10:53 AM
Prelims	28 Boys 11-14 200 IM	56	7u	11:20 AM
	Swimmer Count for Warm-ups: 225	=====	=====	
	Entry / Heat Totals:	636	88	
	Finish Time			11:41 AM

Figure 3: Example meet timeline.

Create PDF of timeline:

- Click printer selection icon
- Select Microsoft print to PDF program
- Exit
- Click print icon
- Click OK
- When prompted, name the file “[name of meet] Preliminary Meet Timeline”
- Save to swim meet database folder
- Click OK

For Neptune club meets, verify 12 and under events are not scheduled to swim over a span more than 4 hours. If 4 hours is exceeded, flag head referee for potential mandatory scratchdown.

Meet Warm-Up Report

This is so the head ref can tell each team how many officials they have to bring:

- Reports
- Warm-Up Sheet
- Select All
- Create report. Make sure it looks like this:

Neptune Swimming

HY-TEK's MEET MANAGER 5.0 - 11/15/2015 Page 1

2015 Swim Like the Dickens - 12/11/2015 to 12/13/2015
Warm-up Sheet (Scratch Factor: 1%)

Warm-up Starts at 04:00 PM

Session: 1 Friday

Day of Meet: 1 Starts at 05:00 PM

Total Athletes: 64 - Women: 48 - Men: 16

	Team	Women	Men	Total	Lane
SRN-PC	NEPTUNE SWIMMING	27	9	36	_____
SON-PC	SONOMA SEA DRAGONS	8	0	8	_____
MP-PC	MARIN PIRATES	4	1	5	_____
MCSO-PC	MENDOCINO COAST SEA DRAGONS	3	1	4	_____
UCD-SN	UCD AQUATICS	3	0	3	_____
UN-PC	UNATTACHED	1	2	3	_____
PCM-PC	PACIFIC COAST MARLINS	0	1	1	_____
TOC-PC	THE OLYMPIC CLUB	1	0	1	_____
UN-CC	Unattached	0	1	1	_____
WA-PC	WESTSIDE AQUADUCKS	1	0	1	_____
YPAC-PC	YMCA PACIFIC AQUATIC CLUB	0	1	1	_____

Figure 4: Example meet warm-up report.

Create PDF of warmup report:

- Click printer selection icon
- Select Microsoft Print to PDF
- Click Exit
- Click print icon
- Click OK
- When prompted, name the file “[name of meet] warm-up report”
- Save to swim meet database folder
- Click OK

Number of Athletes

- Go to Reports, Athlete Rosters.
- Make sure Athletes with No Entries is not selected.
- Create report.
- Arrow to last page and note highest number athlete, i.e. 577.

Email Reports

Email reports to meet director, referees and admin

- Psych sheet or Meet Program
- Preliminary timeline
- Warm-up report

Include number of athletes in body of text. Offer to adjust the reports if needed.

Create and send t-shirt report for club meets only when t-shirt vendor will be present. Ask meet director if this is needed.

- Open CSV file created by Swim Connection and add the last name, first name and team abbreviation for all swimmers manually entered
- Email to meet director so they can send it to the T-shirt vendor.

Back Up Database File

Return Mail-in Entries and Checks to Meet Director

3.7 Address Registration Problems

For Neptune club meets only.

This happens after registration verification response comes from Pacific Swimming. This should come from office-membership@pacswim.org, which as of September 2014 is Laurie Benton, laurie4pc@aol.com.

Save email attachment, usually called REGPROB.rtf.

Open report in text viewer to make sure it's the right meet.

Edit Athlete Information

Edit database per report for:

- Name corrections
- Registration numbers
- LSCs

Here is an example:

```
=====
PC      |                                     THE COMPUTER OPERATOR MUST                                     |
        | |CHANGE SWIMMERS NAME AND/OR REGISTRATION NUMBER AS INDICATED BELOW| |
        |=====
SWIMMERS NAME AS ENTERED          CHANGE SWIMMERS NAME TO          CHANGE REG# TO
VAN BALEN, LUCAS                  031707LUC*VANB
HOFFMAN, HANNAH                   063004HANAHOFF
CASASSA, TYLER                     052304TYLACASA
MCDONALD, MAGGIE                   071005MAG*MCDO
COSTA, ANGELINA                    082606ANG*COST
JEFFERS, MASON                     CHANGE LSC TO SN
URLANDO, ISABELLA                  CHANGE LSC TO SN
URLANDO, GIANLUCA                  CHANGE CLUB TO UN
HARM, ELLA                          CHANGE CLUB TO UN
HARM, EVELYN                        CHANGE CLUB TO UN
WALIMBE, SANIKA                     CHANGE CLUB TO UN
```

Figure 5: Example name, registration number and LSC discrepancy report.

Back Up Database File

Print Discrepancy Reports for Clerk of Course

Print out the team affiliation section for the Clerk of Course. Here is an example:

```

=====
PC      |ENTERED TEAM IS NOT THE SAME AS REGISTERED TEAM|
=====

          REGISTERED ENTERED  ENTERED
SWIMMERS NAME  AGE SEX  CLUB   CLUB  REGISTRATION

HELLAR, SYDNEY    10 G   MP    LVA  061004SYDEHELL
PETERSON, CASEY   11 B   UN    OAPB 070503CAS*PETE
PETERSON, CODY    12 B   UN    OAPB 110101COD*PETE
PETERSON, SYDNEY  12 G   UN    OAPB 110101SYD*PETE
GARCIA, MAYA      8 G   SON   SOMA 112106MAYSGARC
LOPEMAN, LAURA   16 G   SRN   TOC  112197LAUCLOPE
    
```

THE DATE OF LAST COMPETITION WITH THE OLD TEAM IS NOT KNOWN.
 IF THE SWIMMER WANTS TO BE ATTACHED TO THE ENTERED CLUB,
 THE SWIMMER MUST COMPLETE A TRANSFER/CHANGE FORM SO THAT
 COMPLIANCE WITH THE 120 DAY UNATTACHED RULE CAN BE ENFORCED.
 IF MET, THE ENTERED CLUB MAY BE USED. IF NOT, THE SWIMMER
 MUST BE CHANGED TO UNATTACHED (UN). SEND THE TRANSFER FORM
 TO YOUR LSC REGISTRAR

Figure 6: Example team affiliation discrepancy report.

Print unpaid registration report for Clerk Of Course. Here is an example:

RECONCILIATION FOR 2014 Neptune Fall Classic MEET ON 09/27/2014

DATE 9/25/14

TIME 17:29:50

__ CONTACT Hy-Tek, Ltd AT 866-456-5111

=====
PC |THE FOLLOWING SWIMMERS ARE NOT CURRENTLY REGISTERED. |
|YOU MUST REGISTER THEM BEFORE ALLOWING THEM TO SWIM. |
=====

	ENTERED	ENTERED				
SWIMMERS NAME	AGE	SEX	CLUB	REGISTRATION		
ANDREWS-GIBSON, ROBIN	9	B	SRN	031905ROBKANDR		
HAMILTON, KAYLA	13	G	RHC	090801KAYPHAMI		
OWENS, ISABEL	10	G	RHC	070804ISAKOWEN		
OWENS, JULIA	7	G	RHC	121106JULMOWEN		
ROUDEBUSH, ANA	12	G	RHC	040602ANACROUD		
SMITH, ETHAN	13	B	SON	032001ETHASMIT		
BURTIS, ELOISE	12	G	TOC	070102ELOPBURT		
MCDONALD, MAGGIE	8	G	WA	071006MAG*MCDO		

WE NEED A FORM COMPLETED AND A CHECK FOR \$8 FROM THE FOLLOWING ATHLETE:

CHERE, YVETTE 16 G SRN 062398YVERCHER

(\$65 WAS SUBMITTED INSTEAD OF \$73)

Figure 7: Example unpaid registration report.

3.8 Post Volunteer Signups

For Neptune meets only.

Timing System Operators

Full day shift:

- Timing system leader: requires experience in timing equipment operator and intermediary duties and prior approval by meet director.

Half day shifts:

- Timing equipment operator: requires prior training.
- Intermediary: requires prior training.
- Trainee: obtain training to perform

Computer Operators

Full day shift:

- Computer room leader: requires experience in computer operator duties and prior approval by meet director.

Half day shifts:

- 2 computer operators, one for deck seeding and one for results. On the job training available.

Runners

Full day shift:

- Runner leader: requires extensive experience in running duties and prior approval by meet director.

Half day shifts:

- 2 runners, one for deck seeding and one for results. On the job training available.

3.9 Replenish Office Supplies

<u>Category</u>	<u>Item No.</u>	<u>Item</u>	<u>Note</u>
Durable	1	Regular stapler	
	2	Heavy duty stapler	
	3	Pencil sharpener	
	4	Scissors	
	5	Stamp set	REFEREE, STARTER, TIMING (need to replace COLORADO stamp), ANNOUNCER, POST, AWARDS
Consumable	6	White printer paper	
	7	Blue printer paper	For reseeded events that have already been posted
	8	3x10 Address labels	30 per sheet, 1" x 2-5/8", Avery 5160 or equivalent
	9	Blue masking tape	
	10	Laser jet toner	
	11	Regular staples	
	12	Heavy duty staples	
	13	Pencils	
	14	Red ball point pens	For admin
	15	Red ink for stamps	
	16	6 spare AA batteries	For 3 mice that use 2 each

Table 3: Office supply list.

4. At Each Meet

4.1 Set Up Computer Equipment

Done by Computer Room Leader before the meet - preferably 1 to 2 days before - to give time to reconfigure, repair or replace equipment as needed. Bring redundant equipment in case of a single part failure.

Types of equipment configurations:

- Quantum, Dolphin or System 6 timing equipment
- Preseeded or deck-seeded, the latter requiring a separate seeding computer

Equipment List

Item no.	Item	Note
1	Results laptop	
2	Results laptop power supply	
3	Results laptop ethernet cable	
4	Results printer	With white print paper and toner
5	Results printer power cord	
6	Results printer USB cable	Type B to Type A
7	Seeding laptop	Deck seeded meets only
8	Seeding laptop power supply	Deck seeded meets only
9	Seeding laptop ethernet cable	Deck seeded meets only
10	Seeding printer	Deck seeded meets only, with white print paper and toner
11	Seeding printer power cord	Deck seeded meets only
12	Seeding printer USB cable	Type B to Type A, deck seeded meets only
13	Ethernet router/switch	At least 3 ports
14	Ethernet router/switch power supply	
15	Power strip	At least 5 outlets for seeding and results computers and printers and ethernet router/switch
16	Extension cord	For power strip
17	USB to serial adapter	System 6 timing system meets only
18	USB to serial adapter USB cable	System 6 timing system meets only
19-20	2 tables	2.5' x 8', or 4 2.5' x 6'
21-26	6 chairs	computer room leader, two computer operators, lead runner, two other runners
27	Results wireless mouse with USB adapter	
28	Results mouse pad	
29	Seeding wireless mouse with USB adapter	
30	Seeding mouse pad	
31	USB stick	For Quantum, Dolphin and deck seeded meets only; for results sneakernet in case ethernet fails
32	Reliable power source with circuit breaker location known and accessible	
	Serial cable from System 6 to USB to serial adapter	System 6 timing system meets only; counted on timing system equipment list side
	Ethernet cable from timing laptop to computer room router/switch	Quantum, Dolphin timing system meets only; counted on timing system equipment side

Table 4: Computer room equipment list.

Set Up Computer Room

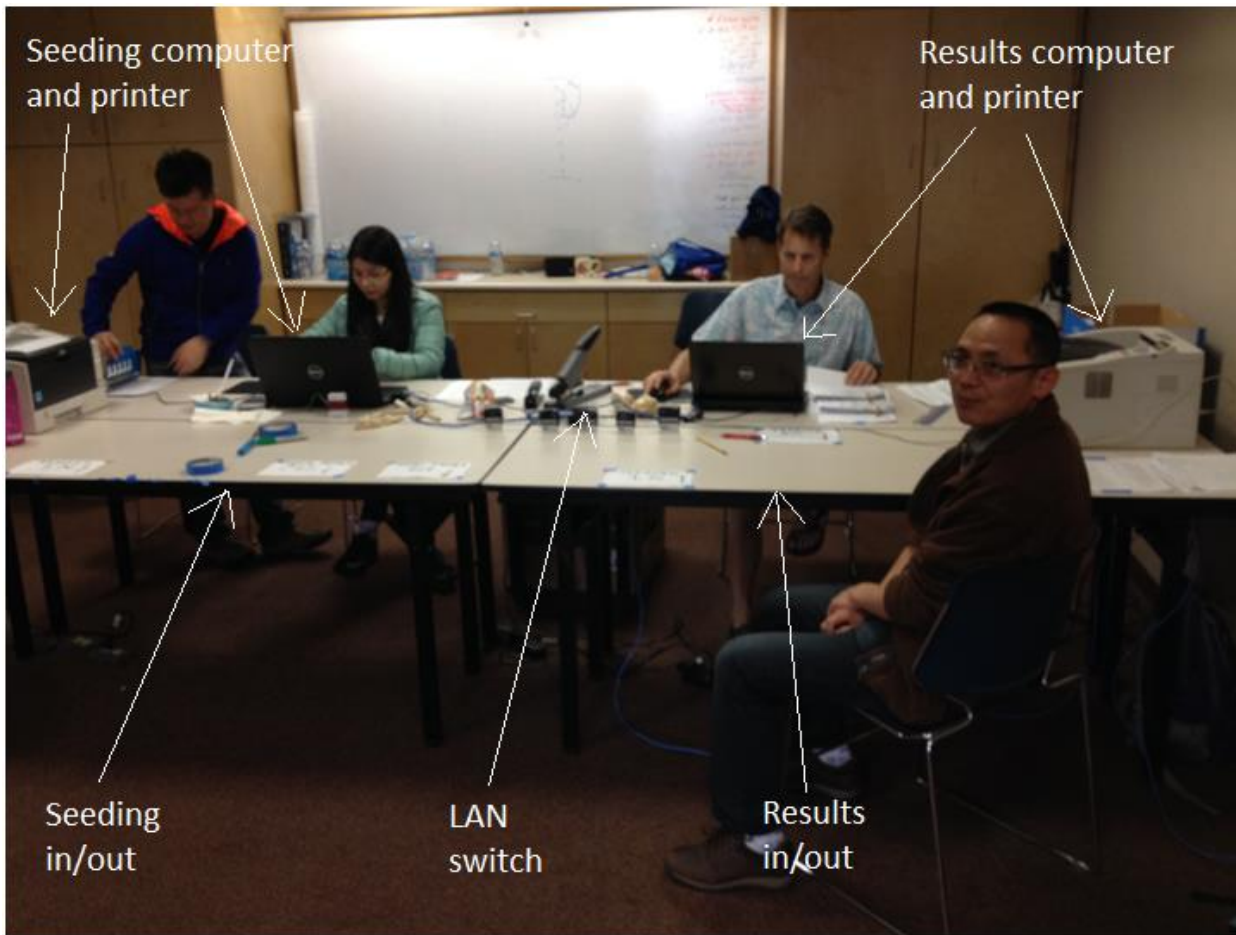

Figure 8: Computer room layout.

Make Electrical Connections

Connection diagram:

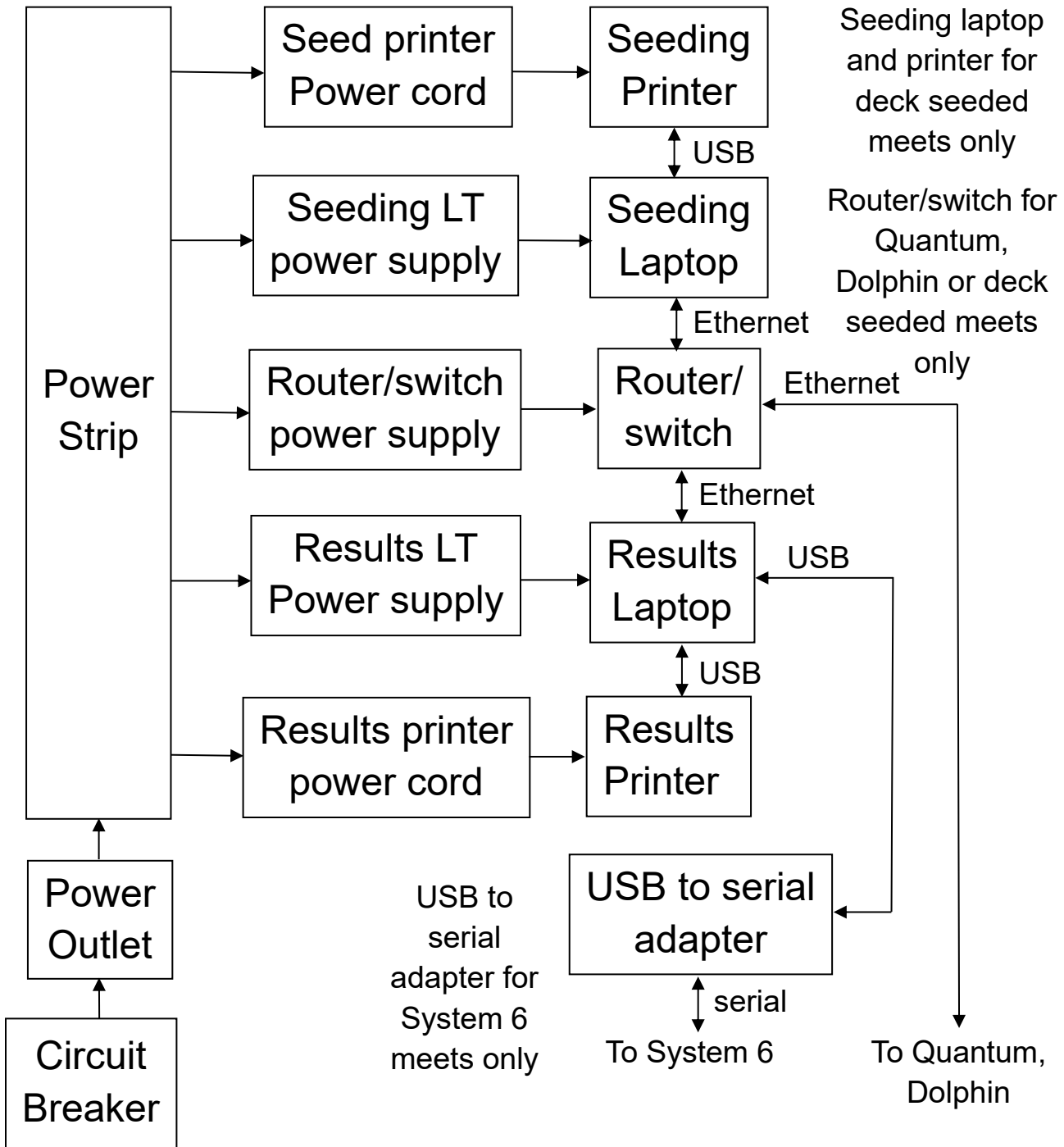

Figure 9: Computer room electrical connection diagram.

Connection list:

	<u>Item</u>	<u>From</u>	<u>To</u>
1	Results laptop power supply	Power strip	Results laptop
2	Results printer power supply	Power strip	Results printer
3	Results printer USB cable	Results laptop	Results printer
4	Results laptop ethernet cable (deck seeded, Quantum or Dolphin meets only)	Results laptop	Router/switch
5	Seeding laptop power supply (deck seeded meets only)	Power strip	Seeding laptop
6	Seeding printer power supply (deck seeded meets only)	Power strip	Seeding printer
7	Seeding printer USB cable (deck seeded meets only)	Seeding laptop	Seeding printer
8	Seeding laptop ethernet cable (deck seeded meets only)	Seeding laptop	Router/switch
9	Router/switch power supply (deck seeded, Quantum or Dolphin meets only)	Power strip	Router/switch
10	USB to serial adapter USB cable (System 6 meets only)	Results laptop	USB to serial adapter
11	Extension cord	Power outlet	Power strip
12	Results wireless mouse USB adapter		Results laptop
13	Seeding wireless mouse USB adapter (deck seeded meets only)		Seeding laptop
	Serial cable from System 6 to USB to serial adapter (System 6 meets only; counted on timing equipment connections list)	System 6	USB to serial adapter
	Ethernet cable from timing laptop to router/switch (Quantum, Dolphin meets only)	Timing computer	Router/switch

Table 5: Computer room electrical connection list.

Turn On Equipment

- Results laptop
- Results printer
- Results wireless mouse
- Seeding laptop (deck seeded meet only)
- Seeding printer (deck seeded meet only)
- Seeding wireless mouse (deck seeded meets only)

Configure Network

Go in to File Explorer and verify Meet Manager computers have the following drives mapped and you are able to see the files on the remote computer:

For all Meet Manager computers for Quantum meets where schedule, athlete names and heat results reside:

Q: \\Quantum1\Hy-Tek Meet Files

For all Meet Manager computers for Dolphin meets where heat results reside:

O: \\timing\CTSDolphin

For Meet manager Seeding and extra computers that needs Meet Manager Results where database file resides:

M: \\Results-SRN\swmeets8

These mapped drives should work if there were no hardware or software changes since the last meet. But if they are not working, re-set up the network by setting encryption level, sharing folders and mapping drives.

Set Encryption Level

On Quantum, Dolphin and Meet Manager Results computers only

Search for and launch Control Panel

Select Network and Sharing Center

Select Change Advanced Sharing Settings

For Private, General Public and All Networks

Turn on Network Discovery (although we don't use the Network tab in File Explorer)

Turn on Automatic Setup of Network Connected Devices

For All Networks

File Sharing Connections: Enable file sharing for devices that use 40- or 56-bit encryption
(not 128-bit default; allows Windows 10 running on older computers to network)

Note: this is not necessary for pre-seeded meets where only 1 ethernet

Cable is used between Quantum and Meet Manager Results computer

Turn off password protected sharing

Find Computer Names

On Quantum, Dolphin and Meet Manager Results computer

In Control Panel select System

Record Device Name, for example Quantum1 or Results-SRN

Share folders

On Quantum Computer

In File Explorer right-click on c:\ Hy-Tek Meet Files

Select Show More Options (Windows 11 only)

Select Give Access To, Specific People

Set Everyone to Read/Write access

Click drop down arrow to the right of Everyone

Select Everyone

Select Add

Select Read/Write

Select Share

On Dolphin Computer

Same as above except In File Explorer right-click on c:\ CTSDolphin

On Results Computer

Same as above except in File Explorer right-click on c:\swmeets8

Map drives

On all Meet Manager Computers for Quantum meets only, map Q to Quantum

In File Explorer, right-click on This PC and select Map Network Drive

Select drive letter Q:

Type in the full share path = \\[computer name]\[share name] = \\Quantum1\Hy-Tek Meet Files

Select Reconnect at sign-in

Select Finish

On all Meet Manager Computers for Dolphin meets only, same as above but map O to Dolphin

Select drive letter O:

Type in the full share path \\timing\CTSDolphin

On Meet Manager Seeding and extra computers only, same as above but map M to Results

Select drive letter M:

Type in the share name \\Results-SRN\Swmeets8

Network Troubleshooting

If you can't map a drive:

- Verify ethernet cables are connected and are locked
 - If cable lockers are broken, replace cable
- Verify ethernet switch is plugged in to AC power and there are green lights blinking at every cable input
 - If not, swap cables to see if there is a bad cable, and if so replace cable
- Verify computers are on the same subnet
 - Run Control Panel
 - Select Network and Internet
 - Select Network and Sharing Center
 - Select Change adapter settings
 - If ethernet connection isn't X'd out, double-click on ethernet connection
 - Click Details
 - Verify DHCP Enabled = Yes
 - Note Autoconfiguration IPv4 address. Examples:
 - Quantum1: 169.254.231.153
 - Results-SRN: 169.254.94.101
 - Seeding-SRN: 169.254.41.1
 - Timing: 169.254.126.231
 - Click Close
 - Make sure all computers have the first 6 subnet digits the same, in this example 169.254
- If DHCP Enabled = No, change to Yes
 - Click Properties
 - Select Internet Protocol Version 4 (TCP/IPv4)
 - Select properties
 - On General tab, select the following items:
 - Obtain IP address automatically
 - Obtain DNS server automatically
 - Note: setting all computers to static IP addresses with the same subnet can also work if necessary but is not advised unless there is no other way to fix this
- If drive still won't map, see if you can ping the computer with the shared drive
 - On the computer trying to do the mapping, search for and launch Command Prompt
 - Type ping [IPv4 address of target computer], for example ping 169.254.231.153
 - If it is working it should reply 4 times with reply time in milliseconds
 - If it is not working it will report a time out 4 times
 - To repeat the ping test after making changes press the up arrow to bring up the last command again

Configure Timing Equipment Interface

On all Meet Manager computers:

- Launch Meet Manager
- Open meet database
- Click Run tab
- Select type of equipment by clicking Interfaces, Setup, Timing Console Interface – Pool 1.
 - For Quantum, select Omega Quantum-AQ File Sharing
 - For Dolphin, select Colorado Time Systems Dolphin with Splits
 - For System 6, select Colorado Time Systems System 6 and Gen 7
- Set up file sharing location for Quantum and Dolphin meets only:
 - Click Interfaces
 - For Quantum
 - Remotely create session folder on Quantum timing equipment computer
 - Select Timer (QAQF) Pool 1
 - Click Select Data Set Stored from QAQF
 - For Dolphin
 - Select Timer (CTSS) Pool 1
 - Click Select Data Set Stored from CTSS
 - Click Update Data Location
 - Navigate to mapped drive, such as Y: for \\Quantum1\Hy-Tek Meet Files and click it
 - For Quantum, select the session folder. It will say No items match your search.
 - Then click Open
 - Select Previous Meet
 - Click Close; do not click Update Data Set.

Configure Alphanumeric Scoreboard

For Quantum meets only.

- Click Setup, Alpha Scoreboard Interface
- Select Network File Sharing IST or Quantum-AQ

Configure Serial Port

For System 6 meets only.

On Meet Manager database computer:

- Run Device Manager
 - Select Ports (COM & LPT)
 - Right click on USB to serial adapter connected to System 6, usually COM5 or COM6, noting this COM number for later. Select Properties
 - Select Port Settings tab and make the following settings:
 - Baud Rate 9600
 - Parity Odd
 - Data Bits 8
 - Stop Bits 1
 - Click OK

- In Meet Manager Run menu, click Interfaces, Timer (CTS6) Pool 1, Open/Close Serial Port for CTS6
 - Enter COM number in to Serial Port for CTS Timer Pool 1 (0-60); found earlier in Device Manager, usually 5 or 6
 - Click OK and communications test should pass

- Troubleshooting, if communications test fails:
 - Try a different serial cable
 - Eliminate the serial cable and plug USB to serial adapter straight in to back of System 6
 - Verify COM port settings in Meet Manager match Device Manager by selecting Interfaces, Timer (CTS6) Pool 1, Configure Serial Port
 - Re-run communication tests by selecting Interfaces, Timer (CTS6) Pool 1, Test Communication with CTS6

Set Up Meet Mobile

Configure Internet Access:

- Verify all computers are still connected to each other via an ethernet switch.
- Connect one Meet Manager computer to the internet, either via stationary WiFi or a wireless hot spot. (Note: Quantum and Dolphin timing computers should not be connected to the internet during the meet.)
- Open Control Panel
 - Click Network and Internet
 - Click Network and Sharing Center
 - Click Change adapter settings
 - Double-click Ethernet connection
 - Click Properties
 - Double-click Internet Protocol Version 4 (TCP/IPv4)
 - Click Advanced
 - De-select Automatic Metric
 - Enter a large number (ex: 100)
 - Click OK, OK, OK, Close
 - Double-click Wi-Fi connection
 - Click Properties
 - Double-click Internet Protocol Version 4 (TCP/IPv4)
 - Click Advanced
 - De-select Automatic Metric
 - Enter a small number (ex: 1)
 - Click OK, OK, OK, Close

Configure Meet Manager:

- Click Set-up, Meet Mobile Publishing
- Click Setting tab:
 - Select Full Meet Data
 - Check Free Heat Sheets
 - Agree to contract (enter name and birthday)
 - Click Confirm
- Click Publish tab:
 - Select Team scoring option (normally Do not publish team scores or no team scores in this meet)
 - De-select Display the event time line (unless explicitly told not to)
 - Click Publish General Meet Information
 - Click Publish Psych Sheets and Heat Sheets

Upon re-opening Meet Manager each time:

- Click Run
- Click Meet Mobile
- Select All to select all events in session
- Select Activate the Meet Mobile System
- Click OK. Green message in upper left should say Meet Mobile Activated.

4.2 Before Each Session

Download Session Event List in to Timing System

For Quantum and System 6 meets only.

For Quantum:

- Remotely create a session folder on the Quantum timing equipment computer, such as “Y:\03042023 High School Invite”.
- In Meet Manager, click Interfaces, Timer (QAQF) Pool 1, Download Events to QAQF. Verify window comes up pointing to the correct file share created above.
- Click Yes
- Verify window says event file complete.
- Click OK. This creates a quantum.sch file in the session folder.
- Ask Quantum timing operator to do the following:
 - Create a new meet for this session
 - Import event schedule
 - Verify the schedule matches the timeline

See Equipment Configuration under Quantum Equipment Setup in the Timing Equipment document.

For System 6:

- Go to System 6 and ask operator to tell you when they are ready to reset and have the meet downloaded.
- In Meet Manager click Interfaces, Timer (CTS6) Pool 1, Download Events to CTS6
 - Select a memory slot in the CTS that is free or can be overwritten. HyTek recommends selecting slot 8 or 9; not sure why.
 - Click OK
 - Wait a couple of minutes while progress messages are displayed. Verify no error messages.
- Go back to System 6 and ask them to verify meet schedule was downloaded by spot checking event length and stroke vs. event number.

Create Check-in Sheets

For deck seeded meets only.

Create Check-In Sheets and deliver them to Clerk of Course.

- Select Reports, Meet Check-In
- For girls, select:
 - Gender = Female
 - Rounds = all rounds
 - Individual + Relays
 - Select session
 - Select All to select all events
 - Entry designator = Event number
 - Parameters – select only:

Show event description

Separate page per age group, for age group only, not Masters

Last name A, Z

Include ages

Double space

- Create Report. Make sure check-in sheet looks like the example on the following page.
 - Click Print icon
 - OK, to print 1 copy
 - Click X
 - Click X
- Repeat for boys.

Zone 3 SC Championships - 1/18/2014 to 1/20/2014

Check-in Report

Session 2 Saturdays Prelims "B" - Day of Meet: 1 - Starts at 11:00 AM
8 & Under Event List - Boys

Event 204 Boys 8&U 100 IM Finals - 5 Entries
Event 210 Boys 8&U 50 Back Finals - 7 Entries
Event 216 Boys 8&U 25 Breast Finals - 6 Entries
Event 220 Boys 8&U 25 Free Finals - 11 Entries
Event 226 Boys 8&U 100 Medley Relay Finals - 1 Entries

Name	Age	Team	204	210	216	220	226
Caberto, A.J.	6	VJO-PC				220	
Cheung, Lucas	8	RAYS-PC		210	216	220	
Friedman, Ethan	8	SSS-PC		210	216	220	226
Ganser, John	6	SRN-PC		210			
Hardin, Otis	8	SRN-PC			216		
Lee, Cameron	8	RAYS-PC	204		216	220	
Margolati, Nicholas	8	MACS-PC				220	
McCarthy, Mathias	6	SSS-PC					226
McCarthy, Tomas	4	SSS-PC					226
Morse, Sam	8	MCSD-PC		210		220	
Obbagy, Ethan	7	SON-PC	204		216	220	
Pugno, AJ	8	SSS-PC					226
Rose, Hayden	8	MCSD-PC	204	210		220	
Smith, Ya'shar	7	SRN-PC	204		216	220	
Valerga, Eric	8	SRN-PC				220	
Whitten, Zachary	8	MP-PC		210		220	
WU, Terrence	8	SRN-PC	204	210			

Figure 10: Example check-in sheet.

Create Scratch Sheets

For deck seeded meets only.

- Select Reports, Psych Sheets
- For girls, select:
 - Gender = Female
 - Rounds = All Rounds
 - Individual + Relays
 - Select session
 - Select All to select all events
 - Columns / Format tab:
 - Columns = Single
 - Format = 1 event per page
 - Double Space
 - Athlete ID = None
 - Time Stamp = Date and Time
 - Include in Psych Tab
 - Deselect everything
 - Filters / Sort Order / Options Tab
 - Filters = None
 - Sort Order = Alphabetical
 - Create Report. Make sure scratch sheet looks like the example on the following page:
 - Click Print icon
 - OK, to print 1 copy
 - Click X
 - Click X
- Repeat for boys.

Replace following screen shot with single column example

Zone 3 SC Championships - 1/18/2014 to 1/20/2014

Psych Sheet - Saturday Prelims "A"

Event 105 Girls 13 & Over 100 Yard Butterfly

	Name	Age	Team	Seed Time			
1	Auva'A, Violani	15	SRN-PC		30	Swanson, Alex	17 NVST-PC
2	Boisseau, Sophie	13	SEBASTOPOL-PC		31	Tapia, Verence	14 NVST-PC
3	Brockley, Piper	16	SRN-PC		32	Thomas, Jamie	13 MP-PC
4	Davison, Maxine	13	MP-PC		33	Tse, Monica	13 FOG-PC
5	Eaton, Jay Jay	13	MP-PC		34	VU, Brooke	13 RAYS-PC
6	Edwards, Hannah	15	WCAN-PC		35	Welsh, Reilly	13 SRN-PC
7	Fong, Sasha	14	SRN-PC		36	Wong, Elizabeth	16 RAYS-PC
8	Frank, Kayla	16	SRN-PC		37	Wong, Victoria	13 RAYS-PC
9	Lam, Kenya	14	MLKB-PC		38	Wright, Kelsea	14 NVST-PC
10	Lax, Catie	13	YPAC-PC		39	Wynne, Jane	14 SRBY-PC
11	Lee, Jessica	16	SRN-PC				
12	Luders, Micaela	17	SRN-PC				
13	Meyer, Amethyst	17	SRN-PC				
14	Mignola, Madeleine	15	YPAC-PC				
15	NG, Priscilla	16	WA-PC				
16	Nowack, Theresa	14	SRN-PC				
17	Oliver, Tessa	13	SRN-PC				
18	Parra, Celine	14	NVST-PC				
19	Pavon, Eva	13	SHSC-PC				
20	Perry, Kaitlyn	16	WA-PC				
21	Powell, Alyssa	15	VJO-PC				
22	Raasch, Shelbi	15	SRN-PC				
23	Ratcliffe, Eva	15	SRN-PC				
24	Roan, Michala	16	SEBASTOPOL-PC				
25	Rosario, Elina	14	VJO-PC				
26	Schlutius, Christy	16	SEBASTOPOL-PC				
27	Senn, Ivylee	17	WA-PC				
28	Shanahan, Laura	17	SRN-PC				
29	Smithstein, Eliana	15	YPAC-PC				

Figure 11: Example scratch sheet.

Create Session Timeline

If there have been changes by head referee to the start time or intervals since the meet setup:

- Select Events, Sessions
 - Double Click on Session
 - Set Start Time, example 03:00
 - Interval (typically 30 sec prelims/timed finals, 45 sec finals to announce names)
 - Extra backstroke interval (typically +15)
 - Click OK
 - Click X
 - Click X

Then create report:

- Select Reports, Sessions
 - Select session
 - Include event start times
 - Include heat and entry count
 - Include *type entries
 - Apply Scratch factor % = what head referee asks for
 - Create report. Make sure it looks like the example on the following page.
 - Click Print icon
- Write "ESTIMATED" on printout.

Zone 3 SC Championships - 1/18/2014 to 1/20/2014
Session Report

Session: 2 Saturdays Prelims "B"

Day of Meet: 1 Starts at 11:00 AM Heat Interval: 30 Seconds / Back +15 Seconds

Round	Event	Entries	Heats	Starts at	
Finals	203 Girls 8 & Under 100 IM	11	2	11:00 AM	_____
Finals	204 Boys 8 & Under 100 IM	5	1	11:05 AM	_____
Prelims	205 Girls 9-10 50 Backstroke	19	3	11:08 AM	_____
Prelims	206 Boys 9-10 50 Backstroke	21	3	11:13 AM	_____
Prelims	207 Girls 11-12 50 Butterfly	13	2	11:17 AM	_____
Prelims	208 Boys 11-12 50 Butterfly	15	2	11:19 AM	_____
Finals	209 Girls 8 & Under 50 Backstroke	12	2	11:22 AM	_____
Finals	210 Boys 8 & Under 50 Backstroke	7	1	11:25 AM	_____
Prelims	211 Girls 9-10 100 Butterfly	8	1	11:27 AM	_____
Prelims	212 Boys 9-10 100 Butterfly	2	1	11:29 AM	_____
Prelims	213 Girls 11-12 100 Backstroke	19	3	11:31 AM	_____
Prelims	214 Boys 11-12 100 Backstroke	15	2	11:37 AM	_____
	Break: 5 Minutes:				
Finals	215 Girls 8 & Under 25 Breaststroke	9	2	11:46 AM	_____
Finals	216 Boys 8 & Under 25 Breaststroke	6	1	11:48 AM	_____
	Break: 5 Minutes:				
Prelims	217 Girls 9-10 100 Freestyle	18	3	11:54 AM	_____
Prelims	218 Boys 9-10 100 Freestyle	16	2	12:00 PM	_____
	Break: 5 Minutes:				
Finals	219 Girls 8 & Under 25 Freestyle	16	2	12:09 PM	_____
Finals	220 Boys 8 & Under 25 Freestyle	11	2	12:10 PM	_____
	Break: 5 Minutes:				
Prelims	221 Girls 11-12 200 Freestyle	12	2	12:17 PM	_____
Prelims	222 Boys 11-12 200 Freestyle	11	2	12:23 PM	_____
Prelims	223 Girls 9-10 50 Breaststroke	20	3	12:29 PM	_____
Prelims	224 Boys 9-10 50 Breaststroke	19	3	12:33 PM	_____
Finals	225 Girls 8 & Under 100 Medley Relay	2	1	12:37 PM	_____
Finals	226 Boys 8 & Under 100 Medley Relay	1	1	12:39 PM	_____
Finals	227 Girls 9-10 200 Medley Relay	5	1	12:42 PM	_____
Finals	228 Boys 9-10 200 Medley Relay	4	1	12:46 PM	_____
	Swimmers Counts for Warm-ups: 150	=====	=====		
	Entry / Heat Totals:	297	49		
	Finish Time			12:50 PM	_____

Figure 12: Example session timeline.

Create Session Program

For deck seeded sessions only. Print as many as asked for by head referee for coaches and officials.

- Select Reports, Psych Sheets
 - Gender = all
 - Rounds = all rounds
 - Indiv + Relays
 - Select session
 - Select All events
 - Columns / Format tab
 - Columns = double or triple, as preferred by head referee
 - Format = blank
 - Athlete ID = none
 - Time stamp = date and time
 - Deselect 1 Event Per Page
 - Include in Psych Sheet tab
 - Time Standards, if time standards meet
 - Entry Times
 - Filter / Sort Order Options
 - Filter = none
 - Sort Order = fast to slow
 - Create Report. Make sure it looks like the example on the next page.
 - Print – select small print icon below big print icon; set for print on both sides
 - Enter number of copies
 - Click OK
 - Click X
 - Click X

Zone 3 SC Championships - 1/18/2014 to 1/20/2014

Psych Sheet

Event 101 Girls 13-14 200 Yard Medley Relay
Zone 3 Meet: 1:53.18 1/13/2007 SANTA ROSA NEPTUNES
 M. DiRado, M. Hannis, J. Ampuero, S. Sims
 2:01.59 FW

Team	Relay	Seed Time
1 SEBASTOPOL-PC	A	2:13.29
1) Boisseau, Sophie 13	2) Bui, Jane 13	
3) Roan, Genna 13	4) Royer, Mikayla 13	
2 NVST-PC	A	NT
1) Wright, Kelsea 14	2) Erickson, Annika Jean 14	
3) Parra, Celine 14	4) Larsen, Natalie 14	
3 MP-PC	A	NT
1) Eaton, Jay Jay 13	2) Thomas, Jamie 13	
3) Davison, Maxine 13	4) Wortzman, Zoe 14	
4 SRN-PC	B	NT
1) Rued, Allyssa 13	2) Welsh, Reilly 13	
3) Clarkson, Reilly 14	4) Caughey, Elizabeth 13	
5 SRN-PC	A	NT
1) Adams, Danica 14	2) Nowack, Theresa 14	
3) Fong, Sasha 14	4) Alameida, Marie 14	
6 RAYS-PC	A	NT

Event 102 Boys 13-14 200 Yard Medley Relay
Zone 3 Meet: 1:42.69 1/17/2009 NORTHBAY AQUATICS
 B. Cline, B. Hartwig, A. Winder, S. Bole
 1:54.79 FW

Team	Relay	Seed Time
1 YPAC-PC	A	NT
1) Lee, Morgan 13	2) Kumar, Hari 14	
3) Amoroso, Thomas 14	4) Lee, Jun 14	
2 NVST-PC	A	NT
1) McMichael, Quinn 14	2) Roberts, Cayd 14	
3) Montoro, Jack 13	4) Cisco, Nicholas 13	
3 SRN-PC	A	NT
1) Murphy, Jack 14	2) Pettibone, Holman 14	
3) Holtschult, Spencer 14	4) Jones, Trevor 14	

Event 103 Girls 15 & Over 200 Yard Medley Relay
Zone 3 Meet: 1:48.01 1/12/2008 NORTHBAY AQUATICS
 D. Roth, E. Kamai, S. Christofferson, L. Slater

Team	Relay	Seed Time
1 VJO-PC	A	NT
1) Augst, Mirelle 16	2) Lanoue, Samantha 16	
3) Powell, Alyssa 15	4) Welton, Mary 18	
2 VJO-PC	B	NT
1) Peterson, Talia 17	2) Singley, Justeen 17	
3) Schoonhoven, Tess 15	4) Peterson, Kaela 15	
3 YPAC-PC	A	NT
1) Trac, Kat 18	2) Smithstein, Eliana 15	
3) Epst, Jag 18	4) Mignola, Madeleine 15	
4 WA-PC	A	NT
1) NG, Priscilla 16	2) NG, Rachel 15	
3) Senn, Ivylee 17	4) Davis, Molly 15	
5 NVST-PC	A	NT
1) Murphy, Haley 18	2) Murphy, Gracie 15	
3) Swanson, Alex 17	4) Schafle, Kathleen 15	
6 SRN-PC	A	NT
1) Bauer, Jenna 18	2) Brockley, Piper 16	
3) Auva'A, Violani 15	4) Luders, Micaela 17	

7 SRN-PC B NT
 1) Nowack, Angelica 18 2) Welsh, Berklee 15
 3) LE, Victoria 16 4) Lee, Jessica 16

Event 104 Boys 15 & Over 200 Yard Medley Relay
Zone 3 Meet: 1:38.16 1/17/2009 NORTHBAY AQUATICS
 Jabri, Denton-Schneider, Kranenburg, Packer

Team	Relay	Seed Time
1 VJO-PC	A	NT
1) Kanzan, Sota 15	2) Miguel, Brandon 17	
3) Sanderson, Daniel 18	4) Viray, Alexander 15	
2 VJO-PC	B	NT
1) Fouad, Izzy 17	2) Everett, Jake 15	
3) Yee, Justin 17	4) Quintana, Xavier 15	
3 RAYS-PC	A	NT
1) Tran, Taylor 15	2) VU, Jordan 15	
3) Phan, Jerry 16	4) Tam, Matthew 17	
4 SRN-PC	A	NT
1) Knox, Jon 18	2) Shinn, Curtis 16	
3) Fong, Shannon 17	4) Keller, Stefan 17	

Event 105 Girls 13 & Over 100 Yard Butterfly
 13-14 Zone 3: 56.49 1/18/2003 Amanda Sims at 2003 Zone 3 Win
 15-16 Zone 3: 54.04 1/15/2005 Amanda Sims at 2005 Zone 3 Win
 17&O Zone 3: 54.13 1/13/2007 Amanda Sims at 2007 Zone3 Wint
 1:00.49 13-14 SECT
 1:00.89 13-14 PRT
 1:04.29 13-14 FW
 1:07.59 13-14 JO
 1:17.79 13-14 PC A
 58.89 15-16 PRT
 1:00.49 15-16 SECT
 1:02.69 15-16 FW
 1:06.19 15-16 JO
 1:15.89 15-16 PC A
 1:00.49 17&O SECT

Meet Qualifying 13-14: 1:13.79
 Meet Qualifying 15-16: 1:15.59
 Meet Qualifying 17&O: 1:16.79

Name	Age	Team	Seed Time
1 Auva'A, Violani	15	SRN-PC	56.66 PRT
2 Luders, Micaela	17	SRN-PC	57.42 SECT
3 Fong, Sasha	14	SRN-PC	58.17 SECT
4 Lee, Jessica	16	SRN-PC	58.68 PRT
5 Swanson, Alex	17	NVST-PC	1:00.77
6 Brockley, Piper	16	SRN-PC	1:01.02 FW
7 Powell, Alyssa	15	VJO-PC	1:01.81 FW
8 Ratcliffe, Eva	15	SRN-PC	1:02.19 FW
9 Rosario, Elina	14	VJO-PC	1:02.34 FW
10 Welsh, Reilly	13	SRN-PC	1:03.28 FW
11 Edwards, Hannah	15	WCAN-PC	1:03.50 JO
12 Schlutius, Christy	16	SSS-PC	1:03.87 JO
13 Mignola, Madeleine	15	YPAC-PC	1:03.99 JO
14 Eaton, Jay Jay	13	MP-PC	1:04.38 JO
15 Boisseau, Sophie	13	SSS-PC	1:04.89 JO
16 Wright, Kelsea	14	NVST-PC	1:05.11 JO
17 Thomas, Jamie	13	MP-PC	1:05.21 JO
18 Wong, Elizabeth	16	RAYS-PC	1:05.35 JO
19 Lam, Kenya	14	MLKB-PC	1:05.75 JO

Figure 13: Example unseeded preliminary session program.

Create Pre-Seeded Session Program

For pre-seeded sessions only including finals, use Meet Program in the Meet Manager software.

- Select Reports, Meet Program
 - Gender = all
 - Rounds = all rounds
 - Indiv + Relays
 - Select session
 - Select All events
 - Columns / Format tab
 - Columns = double or triple, as preferred by head referee
 - Format = blank
 - Athlete ID = none
 - Time stamp = date and time
 - Include in Meet Program tab
 - Time Standards, if time standards meet
 - Entry Times
 - Qualifying alternates
 - Create Report. Make sure it looks like the example on the next page.
 - Print – select small print icon below big print icon; set for print on both sides
 - Enter number of copies
 - Click OK
 - Click X
 - Click X

Zone 3 SC Championships - 1/18/2014 to 1/20/2014
Meet Program - Saturday Finals

Event 201 Girls 11-12 200 Yard Medley Relay

Lane	Team	Relay	Seed Time
Heat 1 of 1 Finals			
2	YPAC-PC	A	NT
	1) Duon, Chl 11	2) Kumar, Uma 11	
	3) Locala, Naomi 11	4) Fisher, Alexa 11	
3	NVST-PC	A	NT
	1) Montoro, Ellie 11	2) Dusky, Emily 12	
	3) Dunn, Erin 12	4) King, Grace 11	
5	SRN-PC	A	NT
	1) Monks, Megan 11	2) Moussa, Grace 12	
	3) Jones, Megan 12	4) Nguyen, Sara 11	
6	MP-PC	A	NT
	1) Devincenzi, Alyssa 12	2) Bauer, Anna 12	
	3) Solomon, Summer 11	4) Cruse, Claire 12	
7	SON-PC	A	NT
	1) Ajax, Kathryn 11	2) Grajczyk, Maya 12	
	3) Boles, Olivia 12	4) Hanson, Meghan 11	

Event 202 Boys 11-12 200 Yard Medley Relay

Lane	Team	Relay	Seed Time
Heat 1 of 1 Finals			
4	NVST-PC	A	NT
	1) Pascual, Iona 11	2) Flanders, Will 11	
	3) McMichael, Barrett 11	4) Wright, Gabriel 12	
5	MP-PC	A	NT
	1) Simpson, Connor 12	2) McIntyre, Zachary 11	
	3) Grini, Carl 11	4) Wellesley-Winter, Ethan 11	

Event 101 Girls 13-14 200 Yard Medley Relay

Lane	Team	Relay	Seed Time
Heat 1 of 1 Finals			
2	SRN-PC	B	NT
	1) Rued, Allyssa 13	2) Welsh, Reilly 13	
	3) Clarkson, Reilly 14	4) Caughey, Elizabeth 13	
3	SRN-PC	A	NT
	1) Adams, Danica 14	2) Nowack, Theresa 14	
	3) Fong, Sasha 14	4) Alameida, Marie 14	
4	SEBASTOPOL-PC	A	2:13.29
	1) Boisseau, Sophie 13	2) Bui, Jane 13	
	3) Roan, Genna 13	4) Royer, Mikayla 13	
5	MP-PC	A	NT
	1) Eaton, Jay Jay 13	2) Thomas, Jamie 13	
	3) Davison, Maxine 13	4) Wortzman, Zoe 14	
6	NVST-PC	A	NT
	1) Wright, Kelsea 14	2) Erickson, Annika Jean 14	
	3) Parra, Celine 14	4) Larsen, Natalie 14	

Event 102 Boys 13-14 200 Yard Medley Relay

Lane	Team	Relay	Seed Time
Heat 1 of 1 Finals			
3	YPAC-PC	A	NT
	1) Lee, Morgan 13	2) Kumar, Hari 14	
	3) Amoroso, Thomas 14	4) Lee, Jun 14	
5	NVST-PC	A	NT
	1) McMichael, Quinn 14	2) Roberts, Cayd 14	
	3) Montoro, Jack 13	4) Cisco, Nicholas 13	
6	SRN-PC	A	NT
	1) Murphy, Jack 14	2) Pettibone, Holman 14	
	3) Holtschult, Spencer 14	4) Jones, Trevor 14	

Event 103 Girls 15 & Over 200 Yard Medley Relay

Lane	Team	Relay	Seed Time
Heat 1 of 1 Finals			
1	SRN-PC	B	NT
	1) Nowack, Angelica 18	2) Welsh, Berklee 15	
	3) LE, Victoria 16	4) Lee, Jessica 16	
2	YPAC-PC	A	NT
	1) Trac, Kat 18	2) Smithstein, Eliana 15	
	3) Epst, Jag 18	4) Mignola, Madeleine 15	
3	NVST-PC	A	NT
	1) Murphy, Haley 18	2) Murphy, Gracie 15	
	3) Swanson, Alex 17	4) Schafle, Kathleen 15	
5	VJO-PC	A	NT
	1) Augst, Mirelle 16	2) Lanoue, Samantha 16	
	3) Powell, Alyssa 15	4) Welton, Mary 18	
6	WA-PC	A	NT
	1) NG, Priscilla 16	2) NG, Rachel 15	
	3) Senn, Ivylee 17	4) Davis, Molly 15	
7	VJO-PC	B	NT
	1) Peterson, Talia 17	2) Singley, Justeen 17	
	3) Schoonhoven, Tess 15	4) Peterson, Kaela 15	
8	SRN-PC	A	NT
	1) Bauer, Jenna 18	2) Brockley, Piper 16	
	3) Auva'A, Violani 15	4) Luders, Micaela 17	

Event 104 Boys 15 & Over 200 Yard Medley Relay

Lane	Team	Relay	Seed Time
Heat 1 of 1 Finals			
2	SRN-PC	A	NT
	1) Knox, Jon 18	2) Shinn, Curtis 16	
	3) Fong, Shannon 17	4) Keller, Stefan 17	
3	RAYS-PC	A	NT
	1) Tran, Taylor 15	2) VU, Jordan 15	
	3) Phan, Jerry 16	4) Tam, Matthew 17	
5	VJO-PC	A	NT
	1) Kanzas, Sota 15	2) Miguel, Brandon 17	
	3) Sanderson, Daniel 18	4) Viray, Alexander 15	
6	VJO-PC	B	NT
	1) Fouad, Izzy 17	2) Everett, Jake 15	
	3) Yee, Justin 17	4) Quintana, Xavier 15	

Figure 14: Example preseeded finals meet program.

Create Consolidated Results of Previous Session

Consolidated results for previous session to post.

- Select Reports, Results
- For girls:
 - Select Gender = female
 - Rounds = All Rounds
 - Indiv + Relays
 - Select session
 - Select All to select all events
 - Columns / Format Tab
 - Report Type Columns = Double
 - Format = none
 - Athlete ID = none
 - Time Stamp = Date/Time
 - Include in Results Tab
 - Time Stds
 - Entry Times
 - No shows
 - Time Trial Events
 - Splits with Prior Results
 - Include Team Scores = None
 - Splits / Sort Order / Selected Teams Tab
 - Splits = Cumulative for touch pads, none otherwise
 - Sort Order = Event # Order
 - Selected teams = All Teams
 - Create Report. Make sure it looks like the example on the next page.
 - Print – select small print icon below big print icon
 - Click OK to print 1 copy
 - Click X
 - Click X
- Repeat for boys.
- Post printouts.

Neptune Swimming Invitational 14-Under - 2/14/2014 to 2/16/2014

Results - Friday February 08, 2013

				12	Konig, Shane M	12	SMST-SN	6:11.13	
				---	Kiziloglu, Ilyas U	12	SMST-SN	NS	
				---	Peterson, Alex M	12	NBA-PC	NS	
Event 2 Boys 13 Year Olds 400 Yard IM									
Name		Age	Team	Finals					
Time									
1	Dolley, Nicholas A	13	SMST-SN	4:26.52					
2	Baker, Alec D	13	OAPB-PC	4:38.59					
3	Johnson, Hayden C	13	AH-SN	4:47.92					
4	Black, Cooper D	13	AH-SN	4:54.19					
5	Chu, Jonathan K	13	SMST-SN	4:55.14					
6	Wheeler, Michael A	13	OAPB-PC	4:55.21					
7	MA, Arden W	13	UN-SN	4:55.31					
8	Madden, John T	13	SRN-PC	5:00.44					
9	Ranaweera, Seth B	13	SMST-SN	5:03.03					
---	Rescate, Noah	13	AH-SN	NS					
---	Sewell, Dylan R	13	AH-SN	NS					
Event 4 Boys 14 Year Olds 400 Yard IM									
Name		Age	Team	Finals					
Time									
1	Richard, Spencer P	14	SMST-SN	4:26.95					
2	Byrne, Zack	14	DAV-SN	4:40.47					
3	Wong, Kyle A	14	UN-SN	4:48.55					
4	Jones, Trevor M	14	SRN-PC	5:00.20					
Event 6 Boys 10 & Under 500 Yard Freestyle									
Name		Age	Team	Finals					
Time									
1	Lomvardas, Akira T	9	NBA-PC	5:55.16					
2	Yamaguchi, Tomo	9	SRN-PC	6:50.33					
3	Lanting, Cole J	10	AH-SN	7:13.39					
4	Follmer, Mac C	10	OAPB-PC	7:16.59					
Event 8 Boys 11 Year Olds 500 Yard Freestyle									
Name		Age	Team						
Prelim Time									
Preliminaries									
1	Nagle, Will H	11	OAPB-PC	5:57.54	q				
2	Finnegan, Jack H	11	NBA-PC	5:57.61	q				
3	Castiglioni, Zeno	11	DAV-SN	6:19.52	q				
4	Coelho, Bruno A	11	SRN-PC	6:23.24	q				
Event 8 Boys 12 Year Olds 500 Yard Freestyle									
Name		Age	Team						
Prelim Time									
Preliminaries									
1	Mefford, Colby J	12	SMST-SN	5:26.43	q				
2	O'Haimhirgin, Finn A	12	SMST-SN	5:33.07	q				
3	Larson, Jax J	12	AH-SN	5:36.28	q				
4	Dillard, Ben D	12	SMST-SN	5:36.63	q				
5	Cannata, Anthony W	12	DAV-SN	5:39.18	q				
6	Twyman, Bernave M	12	OAPB-PC	5:45.77	q				
7	Cariou-Gomez, Theo	12	DAV-SN	5:46.65	q				
8	Giacoppo, Gabriel P	12	NBA-PC	5:47.47	q				
9	Twyman, Cristian H	12	OAPB-PC	5:50.12					
10	Jenkins, Jack R	12	SMST-SN	6:07.02					
11	Dolley, Matthew O	12	SMST-SN	6:10.83					

Figure 15: Example consolidated results report.

Create Session Warmup Report

If requested by head referee, to verify enough officials are there per team.

- Select Reports, Warm Up Sheet
- Select Session
- Create Report

See example in Create Entry Reports section above.

4.3 Seeding

For preseeded meets, the computer leader enters scratches and then seeds the entire meet all at once. For deck seeded meets, the seeding computer operator is responsible for taking scratch sheets from the Clerk of Course and scratching athletes from events, then seeding their heat and lane, then generating reports to post heat and lane, ref sheets, Colorado sheet, announcer sheet, and lane timer sheets. This takes priority over results to keep the meet going and avoid delay of meet, so as soon as seeding is ready, stop results and do seeding, preferably keeping one person always ready to seed. . See appendix for a Seeding checklist.

Enter Relay Teams

Get relay forms from admin. Note that heat and lane has already been assigned:

Event No. 2001 **RELAY ENTRY** Heat 1
Event _____ Lane 2

Name of Club Neptunes Team (Circle One) A B M W (Circle One)

	LAST NAME	FIRST NAME	AGE	SWIMMER MEET I.D. #
1	<u>Clarkson</u>	<u>Reilly</u>	<u>14</u>	
2	<u>Kavan</u>	<u>Julie</u>	<u>12</u>	
3	<u>Nowack</u>	<u>Theresa</u>	<u>14</u>	
4	<u>Adams</u>	<u>Danica</u>	<u>14</u>	

ALTERNATE Marie Almeida
Coach's Signature [Signature]

USA SWIMMING
COMPUTER

Figure 16: Example relay entry card.

- In Meet Manager, go to Relays.
- Select Event.
- For each lane as assigned by admin:
 - Double-click on a swim team
 - Enter relay team suffix A, B, etc
 - Enter entry time if given, ex. 15200 = 1:52.00
 - Enter heat and lane if given, example "1/2"
 - Double click on eligible athletes and they get automatically entered
 - If it tells you they are going over their limit, accept it, since relays usually don't count
 - If Masters or otherwise and exhibition swim, leave out names and select Exhibition
- Close Relay menu.
- Seed relays like individual events – start seeding, then create meet programs, but not heat and lane check-in sheets or lane timer sheets.

Scratch Athletes

- Get scratch lists from the clerk of course for the event. There might be multiple pages if event spans several age groups.
- In Meet Manager, go to Seeding.
- Select session.
- Select event.
- Click Scratch Pad.
 - Click SCR for each swimmer scratched. Be very careful not to scratch the wrong swimmer, especially when more than one swimmer has the same last name.
 - Verify first and last name of each swimmer scratched.
 - Click Save.
- Verify the number of swimmers in the database and the number hand written on the scratch sheets are the same.

Seed The Event

- Click Start Seeding.
- Click OK when seeding is complete.
- Manual seed if a swimmer is added or manually seeded for special needs to the scratch sheet with red lines:
 - Select event
 - Preview
 - Drag And drop swimmers to different lanes
 - Save

Create Start List File

For Quantum meets only so names can be displayed on the video scoreboard:

- Click Run.
- Select event just seeded.
- Click Interfaces, Scoreboard, Customize.
- Select Short Team Name under Relay Names, then click OK
- Click Interfaces, Scoreboard, Create Start List File. This creates quantum.rec and quantum.slx files in the session folder on the timing computer.
- For preseeded meets or the first deck seeded event only, ask the Quantum operator to do the following:
 - Refresh the start list for the whole meet.
 - Confirm that the first event has heats and swimmer names.

Create Event Program

Also called "Ref Sheets". Make 4 to 5 copies:

- 1 for Referee, unless event is one pool length -- 25 yards short course or 50 meters long course -- which requires 2 for Referees, one for each end of the pool
- 1 for starter
- 1 for Colorado
- 1 for Announcer

From the Seeding menu, select Reports, Meet Program.

- If this is the first time running the Meet Program report for seeding since the application was launched, format the report by verifying that only the following are selected:
 - On the top of the form:
 - Gender = All
 - Rounds = All Rounds
 - Indiv + Relays
 - Under the Columns/Format tab:
 - Columns = single
 - Format = 1 event per page
 - Athlete ID = none
 - Time Stamp = date and time
 - Under the Include in Meet Program tab:
 - Entry Times
 - Line for results
 - Qualifying alternates
 - Empty lanes
 - Relay athlete names = 8
 - Top how many = blank
- Select Session.
- If head referee wants two events to alternate heats:
 - Go to Events, Sessions
 - Type second event number in Alt column in first event row and press Enter. This will populate the first event number in the second event row Alt column.
 - Select Event, or two events if alternating.
- Click Create Report. Make sure it looks like this:

Zone 3 SC Championships - 1/18/2014 to 1/20/2014
Meet Program - Saturdays Prelims "B"

Event 203 Girls 8 & Under 100 Yard IM

Lane	Name	Age	Team	Seed Time	Finals	Place
Heat 1 of 2 Timed Finals						
1					_____	_____
2					_____	_____
3	Smith, Ni'ke	8	NEPTUNE SWIMMING-PC	2:01.73	_____	_____
4	Smits, Abby	8	NEPTUNE SWIMMING-PC	1:55.26	_____	_____
5	Breen, Sadie	8	HUMBOLDT SWIM CLUB-PC	1:56.10	_____	_____
6					_____	_____
7					_____	_____
8					_____	_____
Heat 2 of 2 Timed Finals						
1	Hemsworth, Audrey	8	MARIN PIRATES-PC	1:50.18	_____	_____
2	Razo, Kiana	8	MARIN PIRATES-PC	1:44.06	_____	_____
3	Bretz, Layla	7	WESTSIDE AQUADUCKS-PC	1:42.79	_____	_____
4	Gagnon, Anya	8	SEBASTOPOL SEA SERPENTS-PC	1:31.05	_____	_____
5	Heffernan, Lila	7	ST. HELENA SWIM CLUB-PC	1:42.33	_____	_____
6	Melendez, Niccole	8	MLKB-PC	1:42.89	_____	_____
7	Knox, Addy	8	MACS-PC	1:49.31	_____	_____
8	Wrede, Alice	8	ST. HELENA SWIM CLUB-PC	1:55.13	_____	_____

Figure 17: Example event program.

- Click small Print icon below big print icon.
- Enter 3 copies if 50 yards or greater, or 4 copies for 25 yards.
- Click OK. Verify copies are printed by printer.
- Close Print window.
- Close Meet Program window.

Create Heat and Lane Sheets

For deck seeded meets only. For pre-seeded meets, just post another copy of the session program.

Note: if posted heat and lane assignments need to be corrected and are reposted, print on alternative colored paper, not white paper, mark "revised", and ask announcer to mention the change.

- From the Seeding menu, select Reports, Meet Check-In.
- If this is the first time running the Meet Check-In report since the application was launched, format the report by verifying that only the following are selected:
 - On the top of the form:
 - Gender = All, if printing one at a time; for preseeded, do this 2 times, one for female and one for male.
 - Rounds = All Rounds
 - Indiv + Relays
 - Entry Designator = Heat / Lane
 - Under Parameters:
 - Show Event Descriptions
 - Last Name Alphabet Range = A to Z
 - Include Ages (Meet Manager 5 only)
 - Double Space
 - One Event Per Group
 - (Deselect separate page per age group.)
- Select Session.
- Select Event.
- Click Create Report. Make sure it looks like this:

Zone 3 SC Championships - 1/18/2014 to 1/20/2014

Check-in Report

**Session 2 Saturdays Prelims "B" - Day of Meet: 1
8 & Under Event List - Girls**

Event 203 Girls 8&U 100 IM Finals - 11 Entries

	Name	Age	Team
Heat 1 Lane 5.....	Breen, Sadie	8	HSC-PC
Heat 2 Lane 3.....	Bretz, Layla	7	WA-PC
Heat 2 Lane 4.....	Gagnon, Anya	8	SSS-PC
Heat 2 Lane 5.....	Heffernan, Lila	7	SHSC-PC
Heat 2 Lane 1.....	Hemsworth, Audrey	8	MP-PC
Heat 2 Lane 7.....	Knox, Addy	8	MACS-PC
Heat 2 Lane 6.....	Melendez, Niccole	8	MLKB-PC
Heat 2 Lane 2.....	Razo, Kiana	8	MP-PC
Heat 1 Lane 3.....	Smith, Ni'ke	8	SRN-PC
Heat 1 Lane 4.....	Smits, Abby	8	SRN-PC
Heat 2 Lane 8.....	Wrede, Alice	8	SHSC-PC

Figure 18: Example heat and lane sheet.

- Click Print icon.
- Enter 2 copies for JC pool, 1 copy for other pools.
- Click OK. Verify copies are printed by printer.
- Close Print window.
- Close Meet Check-In window.

Create Lane Timer Sheets

For individual events only, not relays. Make 1 copy of Lane Timer Sheets, 1 page per lane, to give to lane timers.

- Select Reports, Lane/Timer Sheets.
- If this is the first time running the Lane/Timer Sheets report since the application was launched, format the report by verifying that only the following are selected:
 - Under Format:
 - 1 event per page per lane
 - Under Parameters:
 - Include entry time
 - Double space
 - Using touch pads, but only if touch pads are being used – may need to be deselected
 - Relay athletes names = 4
 - Lanes 1 – # of lanes being used, i.e. 6, 7 or 8
 - Under Sort By:
 - Lane then event
- Select session.
- Select event.
- Click Create Report. Make sure it looks like this:

Zone 3 SC Championships - 1/18/2014 to 1/20/2014						Official Time	
Event 203 Girls 8 & Under 100 Yard IM Finals							
Lane 1	Heat 1						
Lane 1	Heat 2	Hemsworth, Audrey 8	MP-PC	1:50.18			

Figure 19: Example lane timer sheet.

- Click small Print icon below big print icon.
- Click OK to print 1 copy. Verify copies are printed by printer.
- Close Print window.
- Close Lane/Time Sheets window.

Create Relay Cards

For relays only. For coaches to give to relay captains to give to lane timers, unless multi-carbon copy relay forms were used.

- In Meet Manager, go to Labels, Entry Cards/Labels.
- If this is the first time running Entry Cards/Labels since the application was launched, format the report by verifying that only the following are selected:
 - Gender = All
 - Rounds = All Rounds
 - Indiv + Relays
 - Label Selection = Laser, 3.5" x 8.5" (1x3)
 - Format = Heat/Lane Number
 - Include Entry Time
 - Relay Athlete Names = 8
 - Sort by Event Number
- Select Event.
- Click Create Labels. Make sure it looks like the example on the next page.
- Click small Print icon below big print icon.
- Click OK to print 1 copy. Verify copies are printed by printer.
- Close Print window.
- Close Entry Cards/Labels window.
- Cut entry cards in to 3 with scissors.
- Give to head referee.

Zone 3 SC Championships - 1/18/2014

Event 227 Girls 9-10 200 Yard Medley Relay - Finals Heat: 1 Lane: 2

PIRANHA SWIMMING - A

Seed Time: NT

BK Woodcox, Hailey 10

BR Erickson, Sena 10

FL Honey, Katie 9

FR Lewis, Lexy 9

T1 __:__.__ T2 __:__.__ T3 __:__.__ Official Time __:__.__

Zone 3 SC Championships - 1/18/2014

Event 227 Girls 9-10 200 Yard Medley Relay - Finals Heat: 1 Lane: 3

YMCA PACIFIC AQUATIC CLUB - A

Seed Time: NT

BK Hong, Zoe 10

BR Sugarman, Simone 10

FL Gill, Sydney 9

FR Lee, Ellis 10

T1 __:__.__ T2 __:__.__ T3 __:__.__ Official Time __:__.__

Zone 3 SC Championships - 1/18/2014

Event 227 Girls 9-10 200 Yard Medley Relay - Finals Heat: 1 Lane: 4

MARIN PIRATES - A

Seed Time: NT

BK McIntyre, Kaley 9

BR Lawson, Nina 10

FL Bayer, Bianca 10

FR Caya Blonkenfeld, Blonk 10

T1 __:__.__ T2 __:__.__ T3 __:__.__ Official Time __:__.__

Figure 20: Example relay cards.

Distribute Seeding Reports

Head runner stamps Meet Programs with Referee, Timing, Announcer and Admin stamps, Check-In sheets with Post stamp, and highlight event number on Check-In sheets. See runner section below for details.

Store Scratch Sheets

Staple scratch sheets together if more than one.

Write event number in pencil on back of packet, and place in storage box for results. Staple multi-page scratch sheets together.

4.4 Event Results

The results computer operator is responsible for taking the results packet from the admin, uploading the times from the Quantum, Dolphin or Colorado; make any adjustments to the data as prescribed by the admin, generate a preliminary report for the admin, make any final changes the admin requests, then publish reports to post, announce and give to awards, the latter also with labels to affix to the awards, if applicable. See appendix for a results checklist.

Note: stop results if seeding operator can't keep up – seeding is more critical to keep the meet moving.

If a stack of results comes in, do it in event order.

Move Swimmers

For individual events only. In the Run screen:

- Click Session, select session, then click OK.
- Select event.
- Click Adjust.
- Select Display Eligible Athletes.
- To scratch a swimmer:
 - Double-click on swimmer's name to move them out of their assigned lane and down to the eligible list.
 - Click OK to confirm scratch.
- To add or move a swimmer:
 - Drag and drop the new swimmer in to the lane.
- Click Save.

Move Relay Teams

Go to Relays and make swimmer adjustments, similar to seeding.

Get Times

- Click the heat number if not already highlighted.
- If using Colorado, make sure race number is same as what is noted on Colorado program.
- Click Get Times.
 - If using the Quantum or Dolphin and it says it can't find times, particularly after closing and reopening Meet Manager, you may have to decrement the meet number:
Interfaces, Timer (CTSD), Select Data Stored from CTSD.
Click Previous Meet
Close
Select file number that corresponds with the number hand written on Colorado sheet left margin.
Click OK.
 - If it says times do not match, click Accept anyway.
 - If it says you already downloaded these times, stop and figure out what is going on. Someone may have downloaded results and overwrote a previously scored event.

Verify Times Imported Correctly

Look at heat results printout from Quantum, Dolphin or Colorado printer and verify that all times imported correctly. If the times don't match, verify you are on the right event and heat, and that the meet number and file number on the Colorado Meet Program and heat result printout. Then re-get times.

Verify Primary and Backup Times Agree

If a backup button time is more than 0.3 seconds away from the primary pad time it will be highlighted. Make sure Admin has seen this and approved the primary time.

If there is no backup button time, verify primary time is within 0.3 seconds of the lane timer watch. If there is no lane timer watch time, get the coach's time. If there are any discrepancies report to Admin so they can decide what to do.

Enter DQs

If a swimmer was DQd as noted on the Colorado Sheet, click DQ on the row with their name.

Double check name matches DQ slip written up and added to the packet.

Edit Times

- If a swimmer's time is edited on the Colorado sheet, edit it in Meet Manager by overwriting the Prelim or Final time value. You can skip the colon but you need a period for all manual time entries.
- If extra backup times are present causing a time in a no show lane, delete them and the preliminary or final time and type NS in the preliminary or final time.
- If prelim or final times are slightly off and there are missing or more backup watch times are present when using the Dolphin due to waiting too long and timers clicking their watches again and removing them from the time calculation, edit both the backup and final times to match the screen shot.
- If the result row for a swimmer is highlighted in yellow, it means that there is more than 0.3 seconds spread across the results and that the admin needs to either verify the time calculated or to select a different time, so make sure those results are marked up by the admin and you have edited them accordingly.

Resolve Split and Backup Discrepancies

Look at splits and backup times that are highlighted indicating discrepancies and resolve with Referee if not already marked up in paperwork packet. Backup, lane timer and coach watch times can be consulted to resolve issues such as missed or late touches.

List Preliminary Results

For Preliminary event rounds preceding finals only.

Once all heat times are uploaded and edited:

- Click List. This brings up a results report. Make sure it looks like the example on the next page.
- Verify DQ first and last names.
- Verify order of finish with Referee program sheet. If there is a discrepancy, work with Referee to resolve.
- Print one copy of the report that automatically came up by clicking the printer icon near the upper left.

Neptune Swimming Invitational 14-Under - 2/14/2014 to 2/16/2014

Results

Event 7 Girls 11 Year Olds 500 Yard Freestyle

Name	Age	Team	Seed Time	Prelim Time	
Preliminaries					
1 Tupe, Ayesha Y	11	Sierra Marlins-SN	6:20.05	5:56.52	q
2 Imamoto, Brooke A	11	Davis Aquadarts-SN	6:43.43	6:04.34	q
3 Monks, Megan A	11	Neptune Swimming-PC	6:28.29	6:14.74	q
4 Anderson, Selby B	11	Davis Aquadarts-SN	6:31.71	6:20.17	q
5 Smits, Emma E	11	Neptune Swimming-PC	6:33.33	6:21.07	q
6 Freeworth, Laura M	11	Arden Hills Swim Team-SN	6:38.41	6:26.64	q
7 Harris, Olivia L	11	Davis Aquadarts-SN	6:44.09	6:43.79	q
8 Perkins, Avery W	11	Neptune Swimming-PC	6:55.75	7:25.32	q

Event 7 Girls 12 Year Olds 500 Yard Freestyle

Name	Age	Team	Seed Time	Prelim Time	
Preliminaries					
1 Kwan, Julie M	12	Neptune Swimming-PC	5:29.76	5:27.09	q
2 Jones, Megan M	12	Neptune Swimming-PC	5:42.88	5:40.43	q
3 Flath, Gillie L	12	Orinda Aquatics-PC	6:03.09	5:47.63	q
4 Pineda, Keianna G	12	Davis Aquadarts-SN	6:07.39	5:47.68	q
5 Scobey, Taylor S	12	Neptune Swimming-PC	5:51.93	5:54.40	q
6 Mehl, Emma R	12	Sierra Marlins-SN	6:36.11	5:54.50	q
7 Yule, Katelyn A	12	Sierra Marlins-SN	5:53.92	5:57.54	q
8 Moussa, Grace N	12	Neptune Swimming-PC	5:56.79	5:58.61	q
9 Erickson, Meg S	12	Davis Aquadarts-SN	6:03.85	6:01.53	
10 Rodriguez, Tami D	12	Sierra Marlins-SN	6:13.59	6:04.52	
11 McGaughey, Maddie A	12	Orinda Aquatics-PC	6:04.26	6:11.12	
12 Hickerson, Grace J	12	Davis Aquadarts-SN	5:59.15	6:11.63	
13 Largent, Megan E	12	Sierra Marlins-SN	6:25.98	6:13.23	
14 Largent, Sara K	12	Sierra Marlins-SN	6:28.96	6:14.98	
15 Schmitt, Haley G	12	Sierra Marlins-SN	6:16.87	6:15.29	
16 Keslin, Ainsley N	12	Quicksilver Swimming-PC	6:14.93	6:16.61	
17 Benson, Hayley Sue S	12	Davis Aquadarts-SN	6:38.59	6:48.89	
--- Strong, Mia D	12	Orinda Aquatics-PC	6:35.00	NS	

Event 7 Girls 13 Year Olds 500 Yard Freestyle

Name	Age	Team	Seed Time	Prelim Time	
Preliminaries					
1 Pastushenko, Dasha D	13	Sierra Marlins-SN	5:36.69	5:17.78	q
2 Fackenthal, Amalie K	13	Arden Hills Swim Team-SN	5:19.52	5:30.68	q
3 Denner, Madelynn I	13	Sierra Marlins-SN	5:48.46	5:36.66	q
4 Bartylla, Emily R	13	Arden Hills Swim Team-SN	5:39.16	5:37.10	q
5 Jones, Cassidy N	13	Sierra Marlins-SN	5:48.09	5:47.05	q
6 Beaulieu, Megan C	13	Quicksilver Swimming-PC	5:42.90	5:47.45	q
7 Moroz, Daniela M	13	Orinda Aquatics-PC	5:42.19	5:50.00	q
8 Caughey, Elizabeth C	13	Neptune Swimming-PC	6:00.12	5:50.83	q
9 Denner, Elena M	13	Sierra Marlins-SN	6:10.86	5:52.54	
10 Pride, Rachel E	13	Neptune Swimming-PC	5:50.03	5:55.38	

Figure 21: Example preliminary results report.

Score Final Results

For final event rounds only.

Once all heat times are uploaded and edited:

- Click Score. This brings up a results report.
- Verify DQ first and last names
- Close the report that automatically launches, it isn't in the format we need.
- If manually scoring, such as for Neptune Superfinals:
 - Click JD
 - In JD Points column enter points manually
 - Click Exit
 - Score again
- Select Reports, Results.
- If this is the first time running Results Reports since the application was launched, format the report by verifying that only the following are selected:
 - On the top of the form:
 - Gender = All
 - Rounds = All Rounds
 - Indiv + Relays
 - Under the Columns / Format tab:
 - Report Type Columns = Single
 - Deselect One Event Per Page
 - Athlete ID = None
 - Time Stamp = Date / Time
 - Top How Many = leave blank
 - Page break when gender changes for printing multiple event results
 - Under the Include in Results Tab:
 - Time Stds, if CBA time standards meet
 - Entry Qualifying Time
 - Entry Times
 - No Shows
 - Time Trial Events
 - Points, if scoring meet
 - Prior Results, for finals that had prelims
 - Under the Splits / Sort Order / Selected Teams
 - Splits = Cumulative
 - Sort Order = Event # Order
 - Selected Teams = All Teams
 - On the Preferences tab
 - Select "flag over-achievers with a "+" for Time Standard meets only
 - Click OK
- Select Session.
- Select Event.

- Click Create Report. Make sure it looks like the example on the next page.
- Verify order of finish with Referee sheet. If there is a discrepancy, work with Referee to resolve.
- Click print icon. Verify copy is printed by printer.
- Close Print window.
- Close Results window.

**Neptune Swimming Invitational 14-Under - 2/14/2014 to 2/16/2014
Results - Friday February 08, 2013**

Event 2 Boys 13 Year Olds 400 Yard IM

Meet Qualifying: 5:33.79

Name	Age	Team	Seed Time	Finals Time
1 Dolley, Nicholas A	13	Sierra Marlins-SN	4:31.40	4:26.52
2 Baker, Alec D	13	Orinda Aquatics-PC	4:30.27	4:38.59
3 Johnson, Hayden C	13	Arden Hills Swim Team-SN	4:50.85	4:47.92
4 Black, Cooper D	13	Arden Hills Swim Team-SN	4:54.38	4:54.19
5 Chu, Jonathan K	13	Sierra Marlins-SN	4:58.68	4:55.14
6 Wheeler, Michael A	13	Orinda Aquatics-PC	5:06.44	4:55.21
7 MA, Arden W	13	Unattached-SN	5:04.37	4:55.31
8 Madden, John T	13	Neptune Swimming-PC	4:49.03	5:00.44
9 Ranaweera, Seth B	13	Sierra Marlins-SN	5:24.51	5:03.03
--- Rescate, Noah	13	Arden Hills Swim Team-SN	4:38.58	NS
--- Sewell, Dylan R	13	Arden Hills Swim Team-SN	4:55.37	NS

Figure 22: Example final results report.

Schedule Swim-offs

If two swimmers are tagged with asterisks as having the same time, tell head referee that they need to schedule a swim-off.

Obtain Event Packet Approval

Attach results to top of event packet with clothes pin, and give to runner for approval by Admin.

Correct Results if Needed

When the event packet comes back from the admin via the runner, the results computer operator makes any required corrections, then sends them back to the Admin for final approval.

Distribute Approved Results Reports

for Posting and Announcer. Do for all meets except Masters.

- Select Reports, Results.
- Select Session.
- Select Event.
- Click Create Report.
- Type number of copies to make, 2 to 3:
 - 1 to Post
 - 1 for Awards, if finals and awards are being given for the age group of this event, or 1 for scratch table, if prelims
 - If printing a large number of event results explicitly for awards, display top 8 only
 - If printing for awards that will be sent to teams afterwards, select all events and filter by team
 - 1 for announcer, if prelims
- Click Print icon below big print icon.
- Close Print window.
- Close Results window.

Create Award Labels

For finals if awards are being given.

- Select Labels, Award Labels.
- If this is the first time running Award Labels since the application was launched, format the report by verifying that only the following are selected:
 - Gender = All
 - Rounds = Finals only
 - Indiv + Relays
 - Label Selection = Laser 3 x 10
 - Individual Places = see meet sheet
 - Relay Places = see meet sheet
 - Award Type = Standard Award Label
 - Sort By = Event Number
- Select Session.
- Select Event.
- Click Create Labels. Make sure it looks like this:

Place: 1st Time: 1:27.45 PC A
#203 Girls 8 & Under 100 Yard IM
Gagnon, Anya 8
SEBASTOPOL SEA SERPENTS - 1/18/2014
Zone 3 SC Championships

Place: 2nd Time: 1:34.72 PC A
#203 Girls 8 & Under 100 Yard IM
Razo, Kiana 8
MARIN PIRATES - 1/18/2014
Zone 3 SC Championships

Place: 3rd Time: 1:39.80 PC A
#203 Girls 8 & Under 100 Yard IM
Heffernan, Lila 7
ST. HELENA SWIM CLUB - 1/18/2014
Zone 3 SC Championships

Place: 4th Time: 1:40.29 PC A
#203 Girls 8 & Under 100 Yard IM
Bretz, Layla 7
WESTSIDE AQUADUCKS - 1/18/2014
Zone 3 SC Championships

Place: 5th Time: 1:43.42 PC A
#203 Girls 8 & Under 100 Yard IM
Melendez, Niccole 8
MLK JR. BLUE DOLPHIN YOUTH SWI - 1/18/2014
Zone 3 SC Championships

Place: 6th Time: 1:48.38 PC A
#203 Girls 8 & Under 100 Yard IM
Hemsworth, Audrey 8
MARIN PIRATES - 1/18/2014
Zone 3 SC Championships

Place: 7th Time: 1:52.49
#203 Girls 8 & Under 100 Yard IM
Wrede, Alice 8
ST. HELENA SWIM CLUB - 1/18/2014
Zone 3 SC Championships

Place: 8th Time: 1:53.22
#203 Girls 8 & Under 100 Yard IM
Breen, Sadie 8
HUMBOLDT SWIM CLUB - 1/18/2014
Zone 3 SC Championships

Figure 23: Example award labels.

- Check for number of pages by pressing right arrow key until the page number stops incrementing. Open printer tray and insert as many label pages as needed. Up and down does not matter since they are symmetrical, but some printers are face down, others face up, and it depends on which tray – experiment first time with scratch paper.
- Click small Print icon below big print icon.
- Click OK to print 1 copy. Verify copy is printed by printer.
- Close Print window.
- To print more labels for first time A time award medals:
- Temporarily deselect
- Close Award Labels window.

Prepare Results for Runner

Stamping POST, ANNOUNCER and AWARDS on results reports and give them along with awards labels to runner.

Create Swim-off Events

If a prelim ends with a tie between two swimmers for 8th or 10th place, the last qualifying and alternate swimmers respectively, a swim-off is required to determine who gets that place. The tie for 10th place is denoted with an asterisk and swim-off note here:

Event 41 Girls 13 Year Olds 100 Yard Butterfly

Name	Age	Team	Seed Time	Prelim Time	
Preliminaries					
1	Menzmer, Lizzie G	13 Arden Hills Swim Team-SN	56.59	1:01.71	q
2	O'Brien, Ashleen S	13 Orinda Aquatics-PC	1:01.49	1:03.80	q
3	Welsh, Reilly S	13 Neptune Swimming-PC	1:03.28	1:04.00	q
4	Cosgrove, Zoe	13 Davis Aquadarts-SN	1:04.24	1:05.12	q
5	Gulvady, Maya S	13 Quicksilver Swimming-PC	1:06.10	1:06.22	q
*6	Conrad, Avery S	13 Arden Hills Swim Team-SN	1:06.87	1:06.82	q
*6	Denner, Madelynn I	13 Sierra Marlins-SN	1:08.18	1:06.82	q
8	Pastushenko, Dasha D	13 Sierra Marlins-SN	1:08.76	1:07.15	q
9	Denner, Elena M	13 Sierra Marlins-SN	1:09.25	1:07.17	
*10	Reuter, Tina	13 Arden Hills Swim Team-SN	1:04.84	1:08.62	
*10	Smith, Sydney K	13 Orinda Aquatics-PC	1:05.98	1:08.62	
Swim-Off Required					
12	Moroz, Daniela M	13 Orinda Aquatics-PC	1:11.58	1:10.02	
13	Killeen, Camille R	13 Unattached-PC	1:06.44	1:10.86	

Figure 24: example tie for 10th place requiring a swim-off.

Coordinate the swim-off event with head referee.

To create swim-off event:

- Go to Events tab
- Click Add
- Number the event with the same last two digits, but increment the first digit above regular event numbers
- Individual/Relay = Individual
- Select Gender, male or female
- Select age group
- Select distance
- Select stroke
- Rounds = Timed Finals
- Do not Score Event
- Event Type = Swim-Off Event
- OK

Add swim-off event to session:

- Go to Sessions
- Select session
- Double-click on event to add to session
- Click X
- Click X

Add athletes to swim-off event:

- Go to Athletes tab
- Gender = Both
- Show Relays
- Click on letter of last name of first swimmer
- Click on new event
- Click on letter of last name of second swimmer
- Click on new event
- Click X

Then seed event, create Event Programs and Lane/Time Sheets per instructions in Seeding section.

When race is over, process Swim-Off results per above instructions.

Update original event with new places:

- Go to Run tab
- Select session
- Select event
- Click JD
- Type new places in JD column for both swimmers
- OK
- Click List
- Click OK

Then redo results on the original event.

Create Split-off Events

For the first swimmer in a relay to get an individual qualifying time. They need to fill out a card and gets timers to take times.

Insert picture of filled in split-off form here

Create split-off event:

- Events
- Add
- Number the event with the same last two digits, but increment the first digit above regular event numbers
- Individual/Relay = Individual
- Select Gender, male or female
- Select age group
- Select distance if leg
- Select stroke
- Rounds = Timed Finals
- Do not Score Event
- Event Type = Standard
- OK

Add split-off event to session:

- Sessions
- Select session
- Double-click on event to add to session
- X
- X

Add athlete to split-off event

- Athletes
- Gender = Both
- Click on letter of last name of first swimmer
- Click on new event
- Click on letter of last name of second swimmer
- Click on new event
- X
- Seed the event, per instructions above.
- Score and create results per above.
- Add it as a sub event to the main event.

Assemble and Store Event Packet

- Stack papers in the following order, from top to bottom:
 - Final packet
 - Results
 - Scratch sheets
 - Final packet
 - DQ slips
 - Colorado sheet
 - Referee sheet
 - Timing system heat results printouts
 - Lane timer sheets or relay cards
 - Preliminary packet, same as above, if applicable
 - Scratch sheets with number of event circled on the back of the bottom sheet.
- Staple together with heavy duty stapler.
- Put in box to store for at least 1 year.

Publish results on Meet Mobile

This is automatic.

Print Corrected Results

If posted results need to be corrected, print corrected version on alternative colored paper such as green, not white paper, and mark “revised”.

Create Team Score Report

Team scoring meets only. When asked for by head ref, or at the end of the meet.

- Reports, Scores
- Gender = All
- Individual + Relays
- Standard Events
- Select all sessions
- Select All to select all events
- Format Tab
 - Report Type = Team
 - Report Gender Choices = Combined
 - Athlete Criteria = No age criteria
 - Points = Std Pts
- Grouping / Options tab
 - Grouping = Normal
 - Options = None
- Create Report. Make sure it looks like the example on the next page.
- Print
- Click X to close print window
- Click X to close report window

Zone 3 SC Championships - 1/18/2014 to 1/20/2014**Team Rankings - Through Event 415****Combined Team Scores**

Place	Team	Points
1	NEPTUNE SWIMMING	936
2	MARIN PIRATES	734
3	SFRP ROSSI SWIM TEAM	689
4	NAPA VALLEY SWIM TEAM	687
5	VALLEJO AQUATIC CLUB	530
6	YMCA PACIFIC AQUATIC CLUB	323
7	PIRANHA SWIMMING	226.50
8	SEBASTOPOL SEA SERPENTS	204
9	WESTSIDE AQUADUCKS	197
10	THE OLYMPIC CLUB	117
11	SONOMA SEA DRAGONS	92
12	UKIAH DOLPHINS	87
13	HUMBOLDT SWIM CLUB	83
14	MENDOCINO COAST SEA DRAGONS	69
15	ST. HELENA SWIM CLUB	46
16	SEALS AQUATICS	41
17	WINE COUNTRY AQUATICS OF NAPA	40
18	MLK JR. BLUE DOLPHIN YOUTH SWI	28.50
19	FOG CITY HAMMERHEADS	28
20	USF KORET YOUTH SWIM CLUB	17
21	SAN DOMENICO SWIMMING	14
22	MONTICELLO AQUATIC CLUB SEALS	6
23	UNATTACHED	3
23	BSST	3
Total		5,201.00

Figure 25: Example team score report.

Create Individual Points Report

Individual high point meets only.

- Reports, Scores
- Gender = All
- Individual + Relays
- Standard Events
- Select all sessions
- Select All to select all events
- Format tab
 - Type = individual
 - Athlete Age Criteria
 - For Neptune Invitational:

10	
11	11
12	12
13	13
14	14
- Grouping/Options tab
 - Grouping = Normal
 - Options = Top 10
- Create Report
- Print
- X to close print window
- X to close report window

Insert individual points report example here

Create Masters 50 Free Challenge Report

Santa Rosa Masters Resolution meet only.

Here is the summary of the race from the meet sheet:

“All entrants in the 50 Free are automatically entered at no charge into the Resolution 50 Free Challenge. This “event” will attempt to determine a single winner from all age groups and both sexes. Each participant's times will be adjusted by a multiplier to determine their Resolution Challenge time. The multiplier is the FINA Men’s 50 M Long Course WR divided by FINA Age Group 50 M Long Course WR times participant’s 50 Yard time. Example for a female swimmer in the 60-64 year old age group - FINA WR (20.91) divided by Female 60-64 Record (29.31) times meet time (30.00) = Resolution Challenge Time of 21.40.”

Additional Equipment Required:

- 50 free results computer with Excel, PDF reader, and printer installed and tested
- Printer with power supply, USB B to A cable, paper and toner
- USB flash drive, or preferably LAN cable

Before the meet:

This may be given to you by the meet director, but if not:

Obtain world records

Get from Meet Director, or go to <http://www.fina.org/content/swimming-records> and select Long Course records. Note the mens 50 free record. As of Aug 31 2016 it was 20.91 seconds. (Cesar Cielo of Brazil in Sao Paulo, Brazil, December 18, 2009)

Obtain Masters records

Go to <http://www.fina.org/content/masters-records> and select Current LCM Records.

Right-click on the PDF, select Save As, and save to the meet folder.

Open the file and copy the records for the events in the meet to a spreadsheet. Note: this is error prone, so take your time and double-check your work afterwards. As of 2017 there are 16 age groups (ages 25-104 step 5) x 2 genders = 32 numbers that you need. Assign the 25-29 numbers for the 18-24 age group too.

Calculate ratios

Divide the world record by the masters record for each of the 32 gender-specific age groups. This is the ratio you will apply to their results to obtain the adjusted result used to determine the place in this event.

5.12.3 Right Before the meet starts

Set up and test 50 free results system

Connect power supply to 50 free results computer and turn on.

Connect power supply to 50 free results printer and USB cable from that printer to 50 free results computer and print a test PDF file.

Connect results computer to 50 free results computer with LAN cable. Share a folder on the network on one computer and make sure the other computer can see it. Or alternatively, make sure the USB stick can be seen on both computers.

During the meet:

Process 50 free results normally.

Generate HTML Results file:

In Meet Manager, go to Reports, Results.

Select 50 free event.

Under Report Type, select Flat HTML.

Under Include In Results, deselect everything.

Click Create Report.

Save it to the meet folder; alternately a USB stick. Note for the next event, the report will need to be changed back to not HTML with the appropriate result report parameters.

Transfer HTML file to 50 free results computer. This is best done by networking the 50 free results computer to the Results computer and then share folders; alternatively this can be done with a USB Stick.

Import HTML file to Excel:

Open the HTML file that was saved in Excel.

Save as Excel file, naming such as 2017 Masters Resolution 50 free adjusted results.xlsx.

Sort by gender then age:

Cut and paste men in to different tab and name it "men". Then rename the other tab "women".

For women:

Select column of data, then select Data, Text to Columns.

Select Fixed Width and Next.

Click at the beginning of Name, Age and Club headers to add width breaks.

Click before the largest number, which will probably be 1:xx.xx, or 2 columns to the left of most times which are sub-1 minute times like xx.xx. *Failure to do this step correctly can result in the first person over 60 seconds winning the race.*

Click Finish. Expand out newly filled out rows to show all by double-clicking on their rightmost lines.

Select all the data.

Select Data, Sort.

Select column with age, column C. This should put them in order of age.

Delete all the rows below the results.

Delete seed time column.

Repeat for men.

On women's tab, insert column before name and copy "W" in to each cell.

On men's tab, insert column before name and copy "M" in to each cell.

Adjust results

For women:

Open ratios spreadsheet and copy women's age group and ratio in to the women's tab three columns past the end of the data. Delete the middle world record row just copied in if applicable.

Copy down the matching ratio to the column next to the swimmer's result based on their age. *Note that this is error prone, so go slowly and methodically.*

Calculate the adjusted time next to the ratio by multiplying the ratio by the swimmer's result.

Repeat for men.

Combine and sort by adjusted time:

Create a new tab and name it "combined".

On the first line, put the title, i.e. "2017 Masters Resolution 50Y Free Challenge Results".

On the second line, put the result headers "place gender name age team time ratio adjusted". You can cut and paste this in, then in Data go Text to Columns, delimited, space. Underline these headers.

On the next line, copy in all the data from the women's tab except for the table of ratios.

Below the women's results, copy in all the data from the men's tab except for the table of ratios.

Delete the original place values in the first column.

Select all data and go to Data, Sort, by "adjusted" column.

Format report

With all data still selected, go to Home, borders, all borders.

With all data still selected, go to Home, Font, Calibri, 11, not Bold.

Type in 1 and 2 in the first two places, then select all of the place cells, select Home, Fill, Series and OK.

Select time, ratio and adjusted data and set to 2 decimal places – right click, format cells, number, decimal places = 2, OK.

Adjust first column to just fit "place". Double-click on the rest of the right lines of each column of data to fit it to the right width.

Center place, gender and age columns.

Select Page Layout, Margins, Narrow.

Select Orientation, Landscape.

Select all the data and select Print Area, Set Print Area.

Select scale until it just fits one sheet wide, approximately 160%. Check in Print Preview. It should look like this:

2017 Masters Resolution 50Y Free Challenge Results

<u>place</u>	<u>gender</u>	<u>name</u>	<u>age</u>	<u>team</u>	<u>time</u>	<u>ratio</u>	<u>adjusted</u>
1	F	Richards, Ericka L	37	Santa Rosa Maste-38	24.51	0.81	19.73
2	M	Stanley, Mark	65	Santa Rosa Maste-38	26.54	0.79	21.07
3	M	Wilder, Hugh	68	Santa Rosa Maste-38	26.58	0.79	21.10
4	M	Bessire, Brent	46	Santa Rosa Maste-38	24.82	0.87	21.64
5	F	Dodd, Dina	52	Northern Sierra-38	29.45	0.74	21.82
6	M	Woolard, Woody	52	UC33-33	25.36	0.87	22.01
7	M	Cutting, Steve	58	Tri Valley Maste-38	25.86	0.86	22.11
8	M	Patocchi, Robert J	59	Cal Maritime Aca-38	26.01	0.86	22.24
9	M	McPherson, Andrew M	68	Davis Aquatic Ma-38	28.15	0.79	22.35
10	F	Anderson, Allie A	38	Northern Sierra-38	27.88	0.81	22.44
11	M	Hauck, Brian A	47	Santa Rosa Maste-38	25.74	0.87	22.45
12	M	Virkus, Todd	44	Active Sports-38	25.36	0.90	22.75
13	M	Pettibone, Chip	53	Santa Rosa Maste-38	26.39	0.87	22.91
14	M	Hardisty, Owen P	35	Sonoma Aquatic C-38	25.04	0.92	23.01
15	F	Jaubert, Leslie M	57	Santa Rosa Maste-38	31.64	0.73	23.07
16	M	Mc Cracken, Bill	54	Tri Valley Maste-38	26.64	0.87	23.12
17	M	Novotny, Gregg R	63	Northern Sierra-38	28.46	0.83	23.56
18	M	Cort, Doug A	65	Cal Maritime Aca-38	29.76	0.79	23.63
19	M	Jacobson, Noah	40	Active Sports-38	26.48	0.90	23.75

Save file.

Create PDF of results

Save file as PDF. It will save in the active sheet in the same folder, formatted for printing.

Print results on dedicated 50 free results printer and show to Meet Director for approval and announcement.

Print another copy and post for all to see.

Email results to meet director.

4.5 Runner Duties

The responsibility of the running team is to prepare, distribute, post and collect paperwork in a timely manner to minimize delay of the meet and the posting of results. Runner tasks are to be managed by Head Runner, to be split among 2-3 runners. All tasks must be completed. Priority level indicated which tasks to complete first.

Distribute Deck Seeding Reports

Priority 1, to be done right after each event is seeded to keep the meet going.

Prepare seeding paperwork:

- Meet Programs
 - Stamp “Referee” in upper right corner
2 copies if 25 yards (in 25 yard pool) or 50 meters (in a 50M pool)
otherwise 1 copy
 - Stamp 1 “Starter”
 - Stamp 1 “Timing”
 - Stamp 1 “Announcer”
- Meet Check-In Sheets
 - Stamp “Post” and write event number with a circle around it with a thick pen in upper right corner
2 copies for SRJC
otherwise 1 copy
- Lane Timer Sheets
 - No stamping required

Deliver paperwork:

- Meet Programs to:
 - Referees
 - Starter
 - Timing equipment operator
 - Announcer
- Post Meet Check In sheets for athletes to find their heat and lane (Post by gender); use blue painter’s tape and post in event number order
- Lane Timer sheets to lane timers, not getting in the way of them timing

Runner: Seeding Paperwork

>20 minutes before each event for deck seeded meets

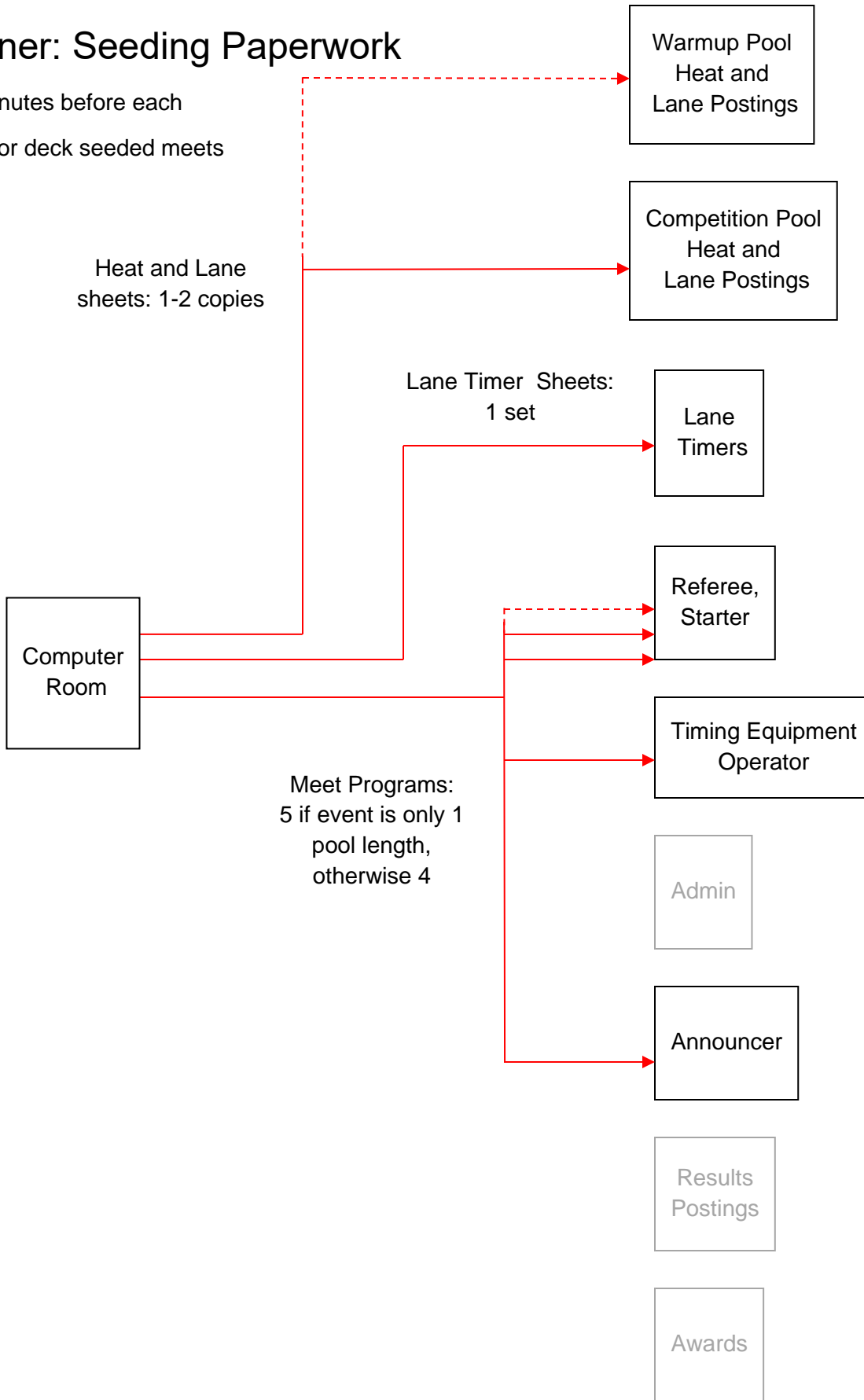

Figure 26: Runner deck seeding delivery diagram.

Collect Lane Timer Sheets

Priority 2, right after each event has been swum.

Collect lane timer sheets right after an event is over, not getting in the way of them timing, and delivers them in lane number order to the Timing Equipment Intermediary.

Runner: Lane Timer Paperwork

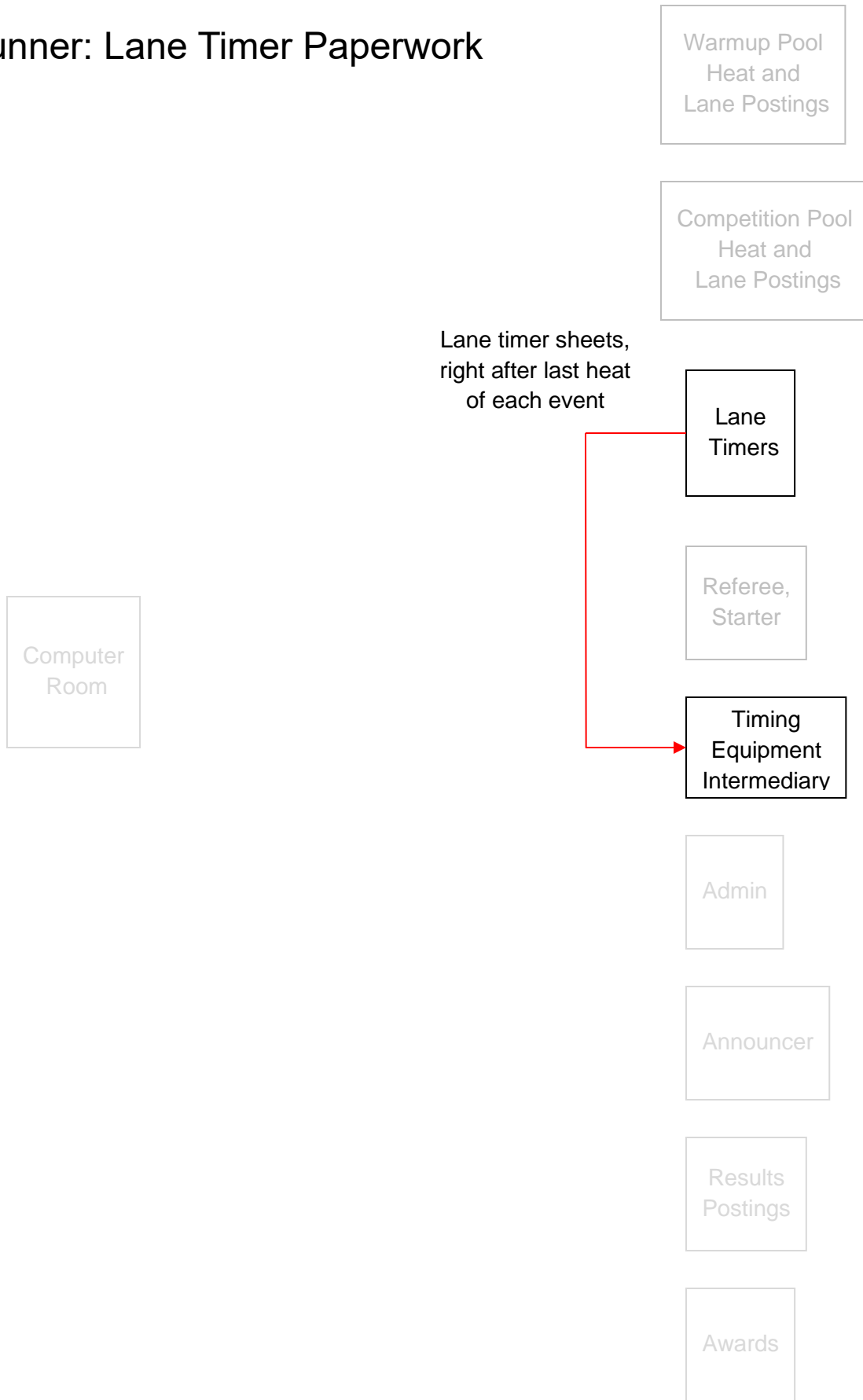

Figure 27: Runner lane timer sheet delivery diagram.

Carry Event Packet Between Admin and Computer Room

Priority 3, after Admin has marked up the event packet.

- Bring event packet from Admin to computer room for preliminary results
- Bring event packets with preliminary results from computer room for Admin approval
- Bring event packet with approved or marked up results from Admin to computer room for final results or corrections
- If corrections were made:
 - Bring packet from computer room back to Admin for review of corrections
 - Bring packet from Admin after corrections reviewed back to computer room

Runner: Event Packet Deliveries

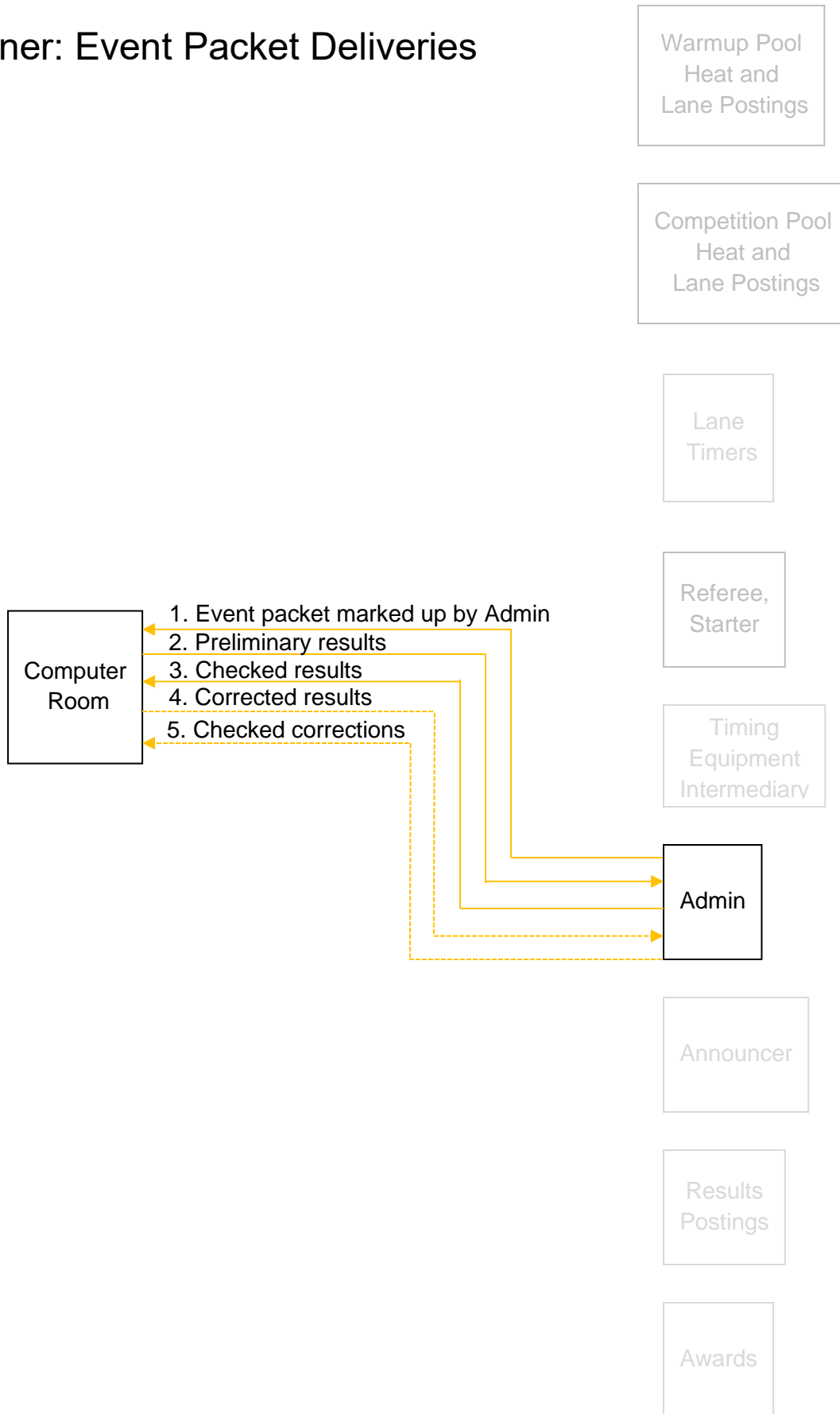

Figure 28: Runner event packet delivery diagram.

Distribute Event Results Reports

Priority 4, once final results are ready for distribution from computer room.

Prepare final results paperwork:

- On Results report:
 - Stamp “Post” on 1 copy
 - Stamps “Awards” on 1 copy, if giving awards for meet & age group
 - Stamp “Announcer” on one copy, if preliminary results
- Awards labels
 - Put underneath Awards results report, if applicable

Deliver paperwork:

- Post final results report for athletes to see their results; use blue painter’s tape and post in event number order by gender
- Deliver 1 final results report and award labels to awards table, if applicable
- Remove Meet Check-In sheets once the events are completed

Runner: Results Paperwork

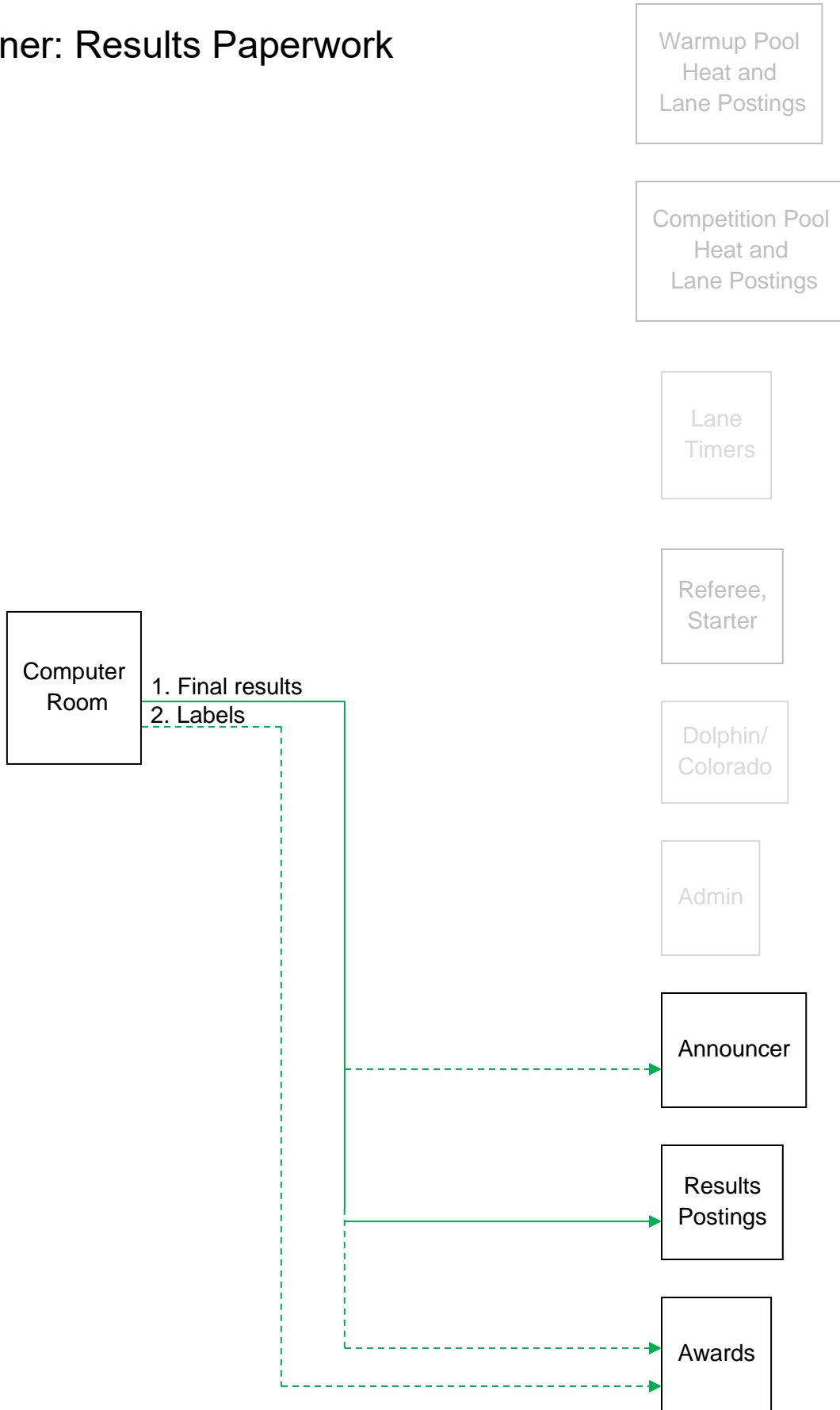

Figure 29: Runner results delivery diagram.

5. After Each Session

Back up database

- Close Meet Manager.
- Copy the MBD File to a separate backup folder on the results hard drive.
- Copy the same MBD file to a backup folder on a USB flash drive or a different computer on the LAN.

6. After Each Meet

6.1 Create Meet Result Files

CL2

For USA Swimming observed meets only.

- File, Export, Results for Team Manager or SWIMS or NCAA Database
- Gender = both
- Events = Standard Events, Time Trial Events and Swim-off Events
- Relays = Relays Plus Athletes
- Include splits = selected
- OK
- OK
- Drive = meet drive
- Directory = meet folder
- OK
- File automatically named [meet name]-[meet date][serial number].zip
- Select ZIP file referenced above with CL2 file
- Right click and select Extract All...
- Extract

HTML

For USA Swimming observed meets only.

Create a main HTML file with all of the results. Then if you are reporting results to the newspaper for a championship event such as high school league, create a second HTML report with only the top 5 results for each event.

- Reports, Results
- Gender = all
- Rounds = All Rounds
- Indiv + Relays = selected
- Session List = All
- Select All to select all events
- Columns / Format tab
 - Export File = Flat HTML (change)
 - Relay Names = 4
 - Athlete ID = None
 - Time Stamp = Date/Time
 - Top how many: blank
- Include in Results tab – only select the following:
 - Time Stds, if time standards meet (change)
- Records, if championship meet such as high school league
 - Entry Qualifying Time, if there were any qualifying times (change)
 - Entry Times
 - No Shows
 - Prior results, if trials/finals meet
 - Athlete / Relay Points, if scoring meet
 - Splits with Prior Results, if using touch pads
 - Include Team Scores = Combined if scoring club meet, or male and female if high school
- Splits / Sort Order / Selected Teams Tab
 - Splits = Cumulative / Subtracted for all results only, not top 5(change)
 - Sort Order = Publication Order
 - Selected Teams = All Teams
- Create Report. Make sure they look like example on next page.
 - Drive = c:
 - Folder = swim meet database folder
 - File Name = [meet name] Results for main report; append “top 5” for newspaper report if applicable
- Save
- OK

Licensed to Zone 3 - Championship Meet HY-TEK's Meet Manager 2/19/2014 04:10 PM
 Neptune Swimming Invitational 14-Under - 2/14/2014 to 2/16/2014
 Results

Girls 10 & Under 50 Yard Freestyle

Meet Qualifying: 35.69					
Name	Age	Team	Seed	Finals	Points
1 Wells, Emily	10	DAV-SN	29.88	29.76	9
2 Prussel, Emily M	10	DAV-SN	31.71	29.90	7
3 Meraz, Isabelle L	10	DAV-SN	31.17	30.90	6
4 Smith, Rea N	9	SRN-PC	31.91	31.30	5
5 Camahort, Julietta	10	NBA-PC	29.92	31.31	4
6 Chan, Kayla M	10	DAV-SN	35.04	31.70	3
7 Dahlgren, Erika R	10	DAV-SN	33.38	31.86	2
8 Howell, Moreya G	10	SRN-PC	32.03	32.10	1
9 Gulvady, Leena S	10	QSS-PC	32.08	32.15	
10 Cariou-Gomez, Celi	10	DAV-SN	32.23	32.25	
11 Castles, Emily A	9	DAV-SN	31.42	32.36	
12 Van DE Heetkamp, M	10	DAV-SN	33.68	32.43	
13 Burke, Emi C	9	SRN-PC	34.24	33.04	
14 Dequine, Sanne A	10	DAV-SN	32.89	33.07	
15 Huang, Lucy K	9	AH-SN	34.65	33.29	
16 Dao, Jadelynn K	10	QSS-PC	35.28	34.29	
17 Fee, Emily C	10	NBA-PC	35.11	34.31	
18 Clarkson, Stella J	9	SRN-PC	35.41	34.35	
19 Ewey, Amaralyn E	10	DAV-SN	33.94	34.52	
20 Urlando, Izzy S	10	AH-SN	32.35	34.61	
21 Thoreson, Isha I	10	DAV-SN	35.46	34.67	
22 MACLURE, Mielle C	10	SRN-PC	35.40	34.96	
23 Altamirano, Angela	10	DAV-SN	34.07	35.23	
24 Flores, Emilia M	9	AH-SN	35.26	35.38	

Girls 10 & Under 100 Yard Freestyle

Meet Qualifying: 1:21.09					
Name	Age	Team	Seed	Finals	Points
1 Turner, Sydney A	10	AH-SN	1:01.82	1:01.08	9
2 Prussel, Emily M	10	DAV-SN	1:06.52	1:05.95	7
3 Castles, Emily A	9	DAV-SN	1:07.97	1:07.96	6
4 Meraz, Isabelle L	10	DAV-SN	1:08.58	1:08.66	5
5 Cariou-Gomez, Celi	10	DAV-SN	1:10.55	1:10.41	4
6 Dahlgren, Erika R	10	DAV-SN	1:12.09	1:10.85	3
7 Dequine, Sanne A	10	DAV-SN	1:12.95	1:11.18	2
8 Smith, Rea N	9	SRN-PC	1:10.55	1:11.23	1
9 Howell, Moreya G	10	SRN-PC	1:14.47	1:12.31	
10 Huang, Lucy K	9	AH-SN	1:16.20	1:12.39	
11 Gulvady, Leena S	10	QSS-PC	1:11.91	1:12.46	
12 Burke, Emi C	9	SRN-PC	1:15.92	1:14.08	
13 Van DE Heetkamp, M	10	DAV-SN	1:14.72	1:14.19	
14 Thoreson, Isha I	10	DAV-SN	1:14.60	1:14.69	
15 Altamirano, Angela	10	DAV-SN	1:14.74	1:15.08	
16 Ewey, Amaralyn E	10	DAV-SN	1:15.82	1:16.46	
17 Urlando, Izzy S	10	AH-SN	1:18.62	1:16.47	
18 Flores, Emilia M	9	AH-SN	1:17.85	1:16.87	
19 MACLURE, Mielle C	10	SRN-PC	1:19.43	1:17.97	
20 Rosendale, Charlot	9	DAV-SN	1:18.99	1:18.28	

Figure 30: Example HTML meet results report.

Full Results PDF

For everyone but the newspaper.

- Click Reports, Results.
- On the top of the form:
 - Gender = All
 - Rounds = All Rounds
 - Indiv + Relays
- Under the Columns / Format tab:
 - Report Type Columns = Single for all but Masters which is double
 - Deselect One Event Per Page
 - Athlete ID = None
 - Time Stamp = Date / Time
 - Top How Many = leave blank
- Under the Include in Results Tab:
 - Time Stds, if CBA time standards meet
 - Entry Qualifying Time
 - Entry Times
 - No Shows
 - Time Trial Events
 - Points, if scoring meet
- Under the Splits / Sort Order / Selected Teams
 - Splits = Cumulative
 - Sort Order = Publication order
 - Selected Teams = All Teams
- On the Preferences tab
 - Select “flag over-achievers with a “+” if a time standards meet
 - Click OK
- Select All Sessions.
- Select All Events.
- Click Create Report.
- Print to Microsoft PDF printer, or use MeetManager 7 built in print to PDF feature.
- Navigate to meet folder.

Top 5 Results PDF

For the newspaper.

Same as above except Under the Columns / Format tab, Top How Many = 5.

Financial report PDF for Pacific Swimming

For Pacific Swimming only.

- Reports
- Teams/Schools
- Exclude Teams with No Athletes
- Sort = Team name
- Entry Fee Summary Tab:
 - Athlete Surcharge = check meet sheet; typically 8.00 for CBA club meets
 - Team Surcharge = check meet sheet; typically 0.00 for CBA club meets, \$200 for Superleague
 - Facility Surcharge = 0.00
 - Include Scratches
 - Include Relay Only Alternates
 - Include Exhibition Swims
- Create Report. Make sure it looks like this:

Licensed To: Zone 3 - Championship Meet

Hy-Tek's MEET MANAGER 2/19/2014 Page 1

Neptune Swimming Invitational 14-Under - 2/14/2014 to 2/16/2014

		Team Entry Fee					
	Team	Relays	Athletes	Entries	Surcharge	Entry Fee	Total
1	AH-SN Arden Hills Swim Team	8	31	218	\$248.00	\$618.75	\$866.75
2	DAV-SN Davis Aquadarts	6	32	205	\$256.00	\$580.25	\$836.25
3	SRN-PC Neptune Swimming	7	46	226	\$368.00	\$640.75	\$1,008.75
4	NBA-PC North Bay Aquatics	1	28	132	\$224.00	\$365.75	\$589.75
5	OAPB-PC Orinda Aquatics	0	25	172	\$200.00	\$470.25	\$670.25
6	QSS-PC Quicksilver Swimming	4	21	125	\$168.00	\$354.75	\$522.75
7	SMST-SN Sierra Marlins	8	33	218	\$264.00	\$616.00	\$880.00
8	UN-PC Unattached	0	8	44	\$64.00	\$121.00	\$185.00
9	UN-SN Unattached	0	7	53	\$56.00	\$145.75	\$201.75
		34	231	1393	\$1,848.00	\$3,913.25	\$5,761.25

Figure 31: Example financial report.

- Select Microsoft Print to PDF printer
- Print
- File name = [meet name] Financial Report

Financial report PDF for Pacific Masters

For Pacific Masters only.

- Reports, Teams
- Format Athlete, Entry Count
- Create Report

ZIP

For coaches who use Team Manager and LSCs. Create one results ZIP file

In Windows Explorer

- Move HTML file in to newly created unzip folder, not top 5 if championship meet
- Select HTML and CL2 files

Move PDF file in to newly created unzip folder

- Right Click, Send to, Compressed (zipped) folder, keeping its default name the same as the CL2 file autname.
- This creates a new zip file in this folder. Rename [meet name] results.zip.

6.2 Distribute Results

Email Full Results

Send to:

- Participating team coaches
- Head referee
- Admin
- Meet director

Email Top 5 Results to Newspaper

If applicable, such as for NBLs. Email results to sports@pressdemocrat.com .

Email Results to Pacific Swimming LSC

For Neptune meets only.

Email new ZIP file with CL2 and main HTML files as an attachment to results@pacswim.org. As of December 2016 this gets sent to Diana Fetterman, dfetterman@pacswim.org . CC meet director, head referee and admin. Title it [meet name] Results. Include your name, email address and phone number in the body of the text.

Email Results to Pacific Masters

For Masters meets only.

All Pacific Masters files to be sent to postmeet@pacificmasters.org within 2 hours of meet end:

- PDF result (2 column/Publication order sort)
- PDF split results if touch pads (1 column/same sort)
- Export MM results
- Send MM meet backup

Filenames should be of the form:

YYYY_MMM_CCC_Results.pdf

YYYY_MMM_CCC_Splits.pdf

where YYYY is the year, MMM is the meet abbreviation and CCC is the course designation.

Email High School Results to Pacific Swimming

For high school championships, send full results PDF to NTV@pacswim.org .

Email Reports to Meet Director

Email financial report PDF file as an attachment to meet director. Copy head referee and admin.

Determine final number of swimmers:

- Go to Reports, Athlete Rosters.
- Deselect Athletes with No Entries.
- Create report.
- Navigate to last page of report, i.e. 9, and note the highest number athlete at the bottom of the page, i.e. 568.
- Inform head referee, admin and meet director of the number.

For Masters only, send 50 free challenge results.

Postal Mail Results to Pacific Masters

They keep the paper results, instead of the meet director for club or high school meets. Done by Meet Director.

7. Appendix

7.1 New Computer Setup

Done by Meet Director, or a designated computer technician, long before a meet.

Computer Software Installation

Windows 10 or 11

- Obtain a USB stick that can be reformatted, another computer, a fast internet connection, and block out up to several hours of download time.
- Use the other computer to create a bootable USB flash drive containing the Windows installer by following the instructions for using the Windows 10 Media Creation Tool at <https://www.microsoft.com/en-us/software-download/windows10>
- Boot the new computer to the new USB stick. It probably requires pressing F12 while booting.
- Select Language.
- Click Install Now.
- Enter Product key if necessary.
- Click Install Windows Only (Custom/Advanced).
- Delete all partitions and Select Unallocated Space, then Click Next.
- Connect to WiFi or Ethernet, if available.
- Click Customize Settings.
- Turn off all options except Smartscreen.
- Click Skip this step if prompted to enter Microsoft account information.
- Enter “Neptune” for User Name and do not enter a password.
- Click “not now” to disable Cortana.
- Run Windows update; if computer device drivers remain missing, download from manufacturer website.
- Unpin all tiles from the Start Menu and shrink.
- Unpin Windows Store from taskbar.
- Go to Settings, Personalization.
 - Lock Screen: Picture
- Task Manager -> Startup, Disable Microsoft OneDrive
- Control Panel -> System and Security -> System -> Computer Domain, Name and Workgroup -> Change Settings -> Change
 - Computer Name: Result-SRN, Seeding-SRN, TimingSystem-SRN
 - Workgroup: WORKGROUP
 - Restart computer
- Control Panel -> Network and Internet -> Network and Sharing Center -> Change Advanced Sharing Settings
- For both Public and Private networks: Network discovery on, File and printer sharing on, Auto setup off
- For All Networks: Password protected sharing off
- Control Panel -> Hardware and Sound -> Power Options
- Change when the computer sleeps, set never put computer to sleep when plugged in – Do Nothing

- If touch screen, File Explorer -> View -> Disable item check boxes
- Edge -> ... -> Settings
- Open Edge with a specific set of pages: <https://www.google.com/>
- open new tabs with a blank page
- Advanced settings -> ..., Settings, Passwords and Autofill, turn off password and form saving
- go to google.com
- Advanced settings -> Change search engine -> set google as default
- Windows Accounts: to change accounts
 - Windows
 - Settings
 - Accounts
 - Switch to Local Account
 - Follow prompts
- To take PIN off
 - Remove PIN -changes it to password
 - Require sign in = Never, to not require PIN when it times out

Printer Driver

- Plug in printer to computer and allow driver to auto install
- Launch Devices and Printers, Right click on the printer attached, and select "Set as default printer." If a window comes up saying "Setting this printer as default will stop managing your default printer", click "OK" to disable printer manager service.

USB Serial Adapter Driver

- Plug in the USB to serial adapter and verify it is recognized in Device Manager. If not, go to manufacturer's website to download driver.

Hy-Tek Meet Manager for Swimming

- Insert Disk, run setup.exe
- Accept the agreement and use default settings
- When Meet Manager starts, disable language prompt at startup
- Pin to taskbar, and create desktop link to C:\Hy-Sport\SwMM5\SwimMM5.exe if not present
- SwimMM5.exe -> Right-click properties -> Compatibility -> Windows 8 mode
- Check for updates, install

CTS Dolphin

- Go to <https://www.coloradotime.com/support-overview/installation-methods/> , click Dolphin tab, and download installer InstallCTSDolphin_[rev number].exe.
- Run the installer.
- Accept the agreement and use default settings.
- Connect Dolphin base USB device. This auto-launches the driver installation.
- Pin C:\CTSDolphin\Dolphin.exe to taskbar.

Gadwin PrintScreen

- Download printscreen (non pro) from <http://www.gadwin.com/download/>
- Extract Zip and Run PrintScreenxxx_Setup.exe
- Launch Gadwin -> Options
- Preferences -> Disable notification messages and auto-hide capture widget
- Image -> Disable all
- Post-Capture Actions -> save to file, enable send capture to printer, disable preview; print setup -> ... -> Orientation: Portrait

Insert instructions on how to set up Ctrl and PrnSc hotkey to automatically print

- Launch dolphin with base attached, Ctrl-PrntScr, Set rectangular area, enter to print, verify only Dolphin window printed portrait, filling page width

Share Folders

See Verify Network Configuration in Set Up Computer Equipment section of At Each Meet chapter.

Dolphin Firmware Update

If the Dolphin device firmware need to be updated – base, watches, starter adapter or scoreboard adapter – go to <https://www.coloradotime.com/support-overview/installation-methods/> , select Dolphin tab and read all instructions – this is time consuming and if done wrong could result in having to send equipment back to CTS for reprogramming at PC board level.

7.2 Troubleshooting Guide

Network Problems

If you are trying to copy files over from the Dolphin to the results laptop or access the Dolphin and the copying never finishes, try power cycling the router. If that does not work, try power cycling the results laptop.

If you don't have access to the Dolphin computer log file system `c:\ctsdolphin` from the results computer but you are confident there is a network connection, add everyone to read access to that folder using Windows Explorer right click Sharing and Security.

If the database is laggy and causing errors such as creating a report with lines but no text, make sure it is hosted on the fastest machine. We switched the host from an older Windows 8 machine to a brand new Windows 10 machine at the same St. Helena meet where 3 computers were used for seeding and results and problems went away. Removing one of the 3 computers from the multi-user mode may have also improved or solved the problem.

If public network is selected, you need to turn off the firewall in Windows. But you should have selected private network during original computer setup and hence the firewall setting shouldn't matter. This was preventing network operation at the same St. Helena meet; it might have also had something to do with they were using a router instead of a switch.

Sometimes computers will not see each other on the network. Windows 10 network discovery seems to be unreliable or otherwise not understood by this author. The workaround as mentioned in the Dolphin and Colorado testing guides is to map network drives:

- Verify all computers are connected to the LAN switch and that the lights are flashing on each end of the cable.
- Check the IP address of each computer in Control Panel, Network and Internet, Network and Sharing Center, Ethernet, select the ethernet connection, and check IPv4 address, such as 192.168.10.101. Then map network drive shares to those computers.
- If there are still problems, Ping each computer to see if they are connected by launching `cmd.exe` and typing `Ping [IP address]` and seeing if 4 replies come back within a few seconds.

If you have an intermittent or broken long ethernet cable running from the Dolphin computer to the computer room, it may be because it has gotten cut going through doorways that accidentally get closed. The cable was replaced around 2015 and is showing wear again in 2019. Here is what you can do:

- Replace the cable, but it can cost dozens of dollars and you may not have time during a meet to do this.
- Move the computer room computers next to the Dolphin and use a short ethernet cable, but it can be very loud and hard to concentrate on seeding and results, and once we had everything on one power strip and it's circuit breaker tripped when all the laser printers started printing. It shouldn't have since the load should have been below 12 amps and a replacement power strip did not trip, but it is something to be aware of.
- Bring a USB stick and transfer files manually every few events, but be careful not to disrupt the Dolphin program while a race is on and it is almost impossible to do this during 25s and 50s with very short time interval breaks in between.
- WiFi has been tried twice before but was unsuccessful, once at Finley and once at Petaluma, around 2015. The link would become intermittent when lots of people stood between the WiFi Wireless Access Point (WAP) and

the Dolphin computer. Spectators, swimmers and officials all get in the way depending on where the two antennas are. They need to be line of site with few or no people in between. This problem of blockage is worse for 5 GHz than it is for 2.4 GHz. Also the distances of 50' to 100' push the limits for some WiFi networks. However these experiments were run with entry level business laptops that were made between 2009 and 2012 and may have had only lower range 802.11g WiFi vs. longer range 802.11n so there is a chance that newer laptops have better reception due to higher power 802.11n or 802.11ac which does not improve range over n but supports n. If you try WiFi, make sure to strategically place the WAP and Dolphin computer to minimize people between them, such as putting the WAP up high and put both the WAP and the Dolphin away from the end of the pool where officials, athletes and spectators can get in the way. And before being convinced that it will work for the rest of the meet make sure to test it during a congested time.

- You could hand enter the results when the packet comes in, but that would be very time consuming, error prone and could injure the computer operators due to repetitive motion so I don't recommend it.

Printer Problems

If too much is sent to a printer and it has a memory error, determine what page was last sent successfully, then start printing from that page.

If you load printer drivers and the printer still doesn't work, you might need to reboot. A window might be telling you this, but it could be buried. But if you made a hotspot from a smart phone, it could take ½ hour to update Windows if this is the first time it's seen the internet in a while!

If the printer jams, remove paper tray, open up doors and top, front and back, remove toner, look for jammed piece of paper, and remove it carefully.

If printer doesn't print or is in error state but it's not out of paper or out of toner:

- Power cycle printer; some printers that fall asleep don't wake up and be seen properly
- Restart Meet Manager; older buggier MeetManager versions did this more often
- Restart laptop and power cycle printer; that's what it took once to fix it
- Try replacing the USB cable. One failed at the St.Helena meet in Sept 2017 that looked corroded.

TBD

Meet Manager Problems

If other computers are shown as logged in and they aren't, close Meet Manager and do the following:

- Control Panel
- Search for File Explorer Options
- Select Show Hidden Files and Folders
- Apply
- Windows Explorer
- Navigate to meet folder
- Delete *.pxx file

If you can't seed or do results because it's locked by someone else, have the other user deselect that event in their seeding or results tab. If it persists, you may have to have the other person do the seeding or results, or restart Meet Manager on both computers.

If you are trying to enter data and it keeps jumping events or otherwise acting erratic, make sure the keyboard and mouse are clear of papers and clutter. If the problem persists, clean the keyboard and track pad of debris, or if it is clean restart computer. If the problem still persists, decommission computer for meet and see if the problem goes away with keyboard and built in track pad removed. Do not get food or drink in to the track pad or keyboard.

If you try to adjust seeding or results and you try to add someone and they don't move and they are highlighted, that means they are already in the event and need to be dragged and dropped, or deleted and re-added in to a different heat and lane. Ideally Colorado/Dolphin timing operator draws line from old to new lane on Colorado program sheet for results.

If you add an athlete to the meet (deck entry) you need to restart Meet Manager on the Run1 computer to resync the athlete, otherwise they won't show up in Scratch Pad.

If all of a sudden Meet Manager can't see the Dolphin race files needed, if the Dolphin was restarted and has a new race number, Meet Manager needs to be restarted and re-pointed to it to see it.

If it says you've already gotten the same time data, stop, you might be overwriting the wrong earlier event and bad things will happen. If you accidentally overwrote something, first figure out what heat and event you just overwrote and fix it.

If it won't let you enter results because it is by lane, deselect by lane.

If it won't save the edited time, edit or delete the backup times that changed.

If you get results, then scratch someone, then re-result, they may still show up in the results report. To remove, remove them from the event under Athletes.

If you keep getting a server not connected error, make sure Meet Manager auto update is disabled, depending on manual pushing of results.

If results are "non-award division" or show time divisions other than CBA:

Go to Setup, Entry/Scoring Preferences and make sure results are awarded based on seed time, not results time.

Go to Events, Standards and verify only C, B and A are selected for scoring.

If results report is not showing DQs or NSs, make sure top how many = blank, not 99.

If points don't show up in results report for scoring meet, get out of run tab and come back in and try again.

If Meet Manager makes a mistake in the results, such as placing someone above someone with a faster time than them, or second division does not start with second place, or the division is listed as a non-award division as opposed to A/B/C but all the configuration settings are correct, the results are corrupted and they need to be recalculated. Try:

Rescore finals or relist prelims.

Re-get times, then rescore or relist.

Restart Meet Manager, then re-get times, rescore or relist.

Restart Windows 10 and Meet Manager, then re-get times, rescore or relist.

Turn off power, then start back up Meet Manager, re-get times, rescore or relist.

If time divisions are repeated i.e. "AAAA AAAA" instead of "AAAA" go to Events, Time Standards, and remove comments from division tag boxes that the database setup person entered in Standard Description.

If Rescore crashes program, restart program and press Score again.

If you accidentally delete a session, recreate the session and add back in the events and if the events have been scored the results will still be there.

7.3 Seeding Checklist

For each event:

Add swimmers, if needed

In Scratch Pad:

- Select scratch for scratched athletes
- Double check first and last names
- Save

Verify scratches count matches clerk of course notes

Start Seeding

Manual seed if necessary, using Preview

Push start list file to Quantum Scoreboard

Create reports:

4 or 5 Meet Programs – 5 for 25 yard/50 meter races, otherwise 4

- 2 for referees if 25 yard races, otherwise 1
- 1 for Starter
- 1 for Colorado
- 1 for Announcer

1 or 2 Meet Check-ins – 2 for SRJC, otherwise 1

- 1 for wall behind blocks
- 1 for warm-up pool area

1 copy of a set of Lane Timer sheets --- 6 to 8 sheets total, depending on number of lanes

Write event number on back of scratch sheet with a circle around it and store it in a pile until results

This page intentionally left blank so results checklist prints out on a separate page.

7.4 Results Checklist

Seeding takes priority.

Work on earliest event number no matter what status level.

From top level menu select Run, then select Session.

For each event:

- Select event
- Move or add swimmers or relay teams as needed, using Adjust
- For each heat:
 - Determine result race number (Colorado CTS) or file number (Dolphin) on the Colorado sheet left margin
 - Get times, verifying correct event and heat
 - Verify prelim/final times with timing equipment printout
 - DQ as needed
 - Resolve split and backup discrepancies
 - Edit times as needed
- Score (final) or List (prelim)
- Re-verify DQ and NS names and time edits
- Close score/list report, then create and print preliminary result report with proper format for admin approval
- Verify order of finish with Referee sheet

Once admin approves:

- Print 2-3 more Result reports
 - 2 for prelims – 1 to post, 1 for announcer
 - 1 to 3 for finals/timed finals – 1 to post, 1 for announcer if announcing results, and 1 for awards if awards are being given for this event
- Print Labels, if finals and awards are being given to that event
- Staple finals, prelims and scratch sheets together with large stapler and store