



Radian Series Inverter/Charger

GS4048A

GS8048A



Operator's Manual



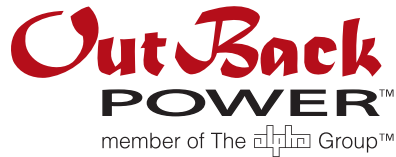

About OutBack Power Technologies

OutBack Power Technologies is a leader in advanced energy conversion technology. OutBack products include true sine wave inverter/chargers, maximum power point tracking charge controllers, and system communication components, as well as circuit breakers, batteries, accessories, and assembled systems.

Applicability

These instructions apply to OutBack inverter/charger models GS4048A and GS8048A only.

Contact Information

Address:	Corporate Headquarters 17825 – 59th Avenue N.E. Suite B Arlington, WA 98223 USA	European Office Hansastraße 8 D-91126 Schwabach, Germany
Website:	http://www.outbackpower.com	

Disclaimer

UNLESS SPECIFICALLY AGREED TO IN WRITING, OUTBACK POWER TECHNOLOGIES:

(a) MAKES NO WARRANTY AS TO THE ACCURACY, SUFFICIENCY OR SUITABILITY OF ANY TECHNICAL OR OTHER INFORMATION PROVIDED IN ITS MANUALS OR OTHER DOCUMENTATION.

(b) ASSUMES NO RESPONSIBILITY OR LIABILITY FOR LOSS OR DAMAGE, WHETHER DIRECT, INDIRECT, CONSEQUENTIAL OR INCIDENTAL, WHICH MIGHT ARISE OUT OF THE USE OF SUCH INFORMATION. THE USE OF ANY SUCH INFORMATION WILL BE ENTIRELY AT THE USER'S RISK.

OutBack Power Technologies cannot be responsible for system failure, damages, or injury resulting from improper installation of their products.

Information included in this manual is subject to change without notice.

Notice of Copyright

Radian Series Inverter/Charger Operator's Manual © 2017 by OutBack Power Technologies.
All Rights Reserved.

Trademarks

OutBack Power, the OutBack Power logo, and Grid/Hybrid are trademarks owned and used by OutBack Power Technologies, Inc. The ALPHA logo and the phrase "member of the Alpha Group" are trademarks owned and used by Alpha Technologies Inc. These trademarks may be registered in the United States and other countries.

Date and Revision

September 2017, Revision B

Part Number

900-0161-01-01 Rev B



Table of Contents

Introduction	7
Audience	7
Symbols Used	7
General Safety	7
Welcome to OutBack Power Technologies	8
Inverter Functions	9
GS8048A	10
GS4048A	10
Inverter Controls	10
MATE3-Class System Display and Controller	10
Operation.....	11
Inverter Functionality.....	11
Description of AC Input Modes	11
Generator	12
Support	13
Grid Tied	14
Grid Interface Protection Menu	15
UPS	16
Backup.....	16
Mini Grid	16
GridZero	18
Description of Inverter Operations	21
Inverting.....	21
DC and AC Voltages.....	21
AC Frequency.....	22
Search	23
Input.....	24
AC Current Settings	24
AC Source Acceptance.....	25
Generator Input.....	26
Transfer	26
Battery Charging.....	27
Charge Current	27
Charge Cycle	28
Advanced Battery Charging (ABC)	29
Charging Steps	29
New Charging Cycle	31
Equalization	34
Battery Temperature Compensation.....	34
Offset	36
Grid Support	37
Auxiliary Terminals	39
Metering	43
MATE3-Class System Display Screens	43
Inverter Screens	43
Battery Screen.....	44

Table of Contents

Troubleshooting	45
Basic Troubleshooting	45
Module Select.....	50
Error Messages.....	51
Warning Messages	52
Temperature Events	53
Grid Tie Warnings.....	53
Disconnect Messages.....	54
Sell Status.....	55
Specifications	57
Electrical Specifications	57
Mechanical Specifications.....	58
Environmental Specifications.....	59
Temperature Derating	59
Regulatory Specifications	60
Listings	60
Certifications.....	60
Compliance.....	60
Limiting Charge Current (Multiple Inverters).....	61
Firmware Revision	63
Default Settings and Ranges	63
Definitions	68
Index	69

List of Tables

Table 1	Summary of Input Modes	19
Table 2	Charge Currents for Radian Models	27
Table 3	Offset Interaction with AC Source	36
Table 4	AUX Mode Functions	42
Table 5	Troubleshooting.....	45
Table 6	Error Troubleshooting.....	51
Table 7	Warning Troubleshooting	52
Table 8	Inverter Temps	53
Table 9	Grid Tie Warnings	53
Table 10	Disconnect Troubleshooting.....	54
Table 11	Sell Status Messages	55
Table 12	Electrical Specifications for Radian Models.....	57
Table 13	Mechanical Specifications for Radian Models	58
Table 14	Environmental Specifications for Radian Models	59
Table 15	Chargers On and Current Settings.....	62
Table 16	Charge Currents for Calculations	62
Table 17	Radian Menu Items	63
Table 18	Terms and Definitions	68

List of Figures

Figure 1	Radian Series Inverter/Charger.....	8
Figure 2	Charging Stages Over Time	28
Figure 3	Charging Stages Over Time (24/7).....	28
Figure 4	Repeated Charging (1 st and 2 nd Cycles).....	32
Figure 5	Repeated Charging (3 rd , 4 th , and 5 th Cycles)	33
Figure 6	Grid Support Function Screen	38
Figure 7	Home Screen	43
Figure 8	Inverter Screens	43
Figure 9	Battery Screen.....	44
Figure 10	AC Test Points	45
Figure 11	Temperature Derating	59

Table of Contents

THIS PAGE INTENTIONALLY LEFT BLANK.







Introduction

Audience

This book provides instructions for the functional settings and operation of this product. These instructions are for use by qualified personnel who meet all local and governmental code requirements for licensing and training for the installation of electrical power systems with AC and DC voltage up to 600 volts. This product is only serviceable by qualified personnel. Do not use this product without reading the *Radian Series Inverter/Charger Installation Manual*.

Symbols Used



	WARNING: Hazard to Human Life This type of notation indicates that the hazard could be harmful to human life.
	CAUTION: Hazard to Equipment This type of notation indicates that the hazard may cause damage to the equipment.
	IMPORTANT: This type of notation indicates that the information provided is important to the installation, operation and/or maintenance of the equipment. Failure to follow the recommendations in such a notation could result in voiding the equipment warranty.
	NOTE: This type of notation indicates useful information. This symbol is not always used.



MORE INFORMATION

When this symbol appears next to text, it means that more information is available in other manuals relating to the subject. The most common reference is to the *Radian Series Inverter/Charger Installation Manual*. Another common reference is the system display manual.

General Safety

	WARNING: Limitations on Use This equipment is NOT intended for use with life support equipment or other medical equipment or devices.
	WARNING: Reduced Protection If this product is used in a manner not specified by GS product literature, the product's internal safety protection may be impaired.
	CAUTION: Equipment Damage Only use components or accessories recommended or sold by OutBack Power Technologies or its authorized agents.

Welcome to OutBack Power Technologies

Thank you for purchasing the OutBack Radian Series Inverter/Charger. It is designed to offer a complete power conversion system between batteries and AC power.

As part of an OutBack Grid/Hybrid™ system, it can provide off-grid power, grid backup power, or grid-interactive service which sells excess renewable energy back to the utility.



Figure 1 Radian Series Inverter/Charger

Inverter Functions

- Battery-to-AC inverting which delivers power to run backup loads and other functions
 - ~ Provides split-phase output
 - ~ Adjustable range of output voltage
 - ~ Settable nominal output frequency
- AC-to-battery charging (OutBack systems are battery-based)
 - ~ Accepts a wide variety of AC sources
 - ~ Requires split-phase input
- Uses battery energy stored from renewable resources
 - ~ Can utilize stored energy from many sources (PV arrays, wind turbines, etc.)
 - ~ OutBack FLEXmax charge controllers will optimize PV power production as part of a Grid/Hybrid system
- Dual AC inputs allow direct connection to utility grid and AC generator
- Rapid transfer between AC source and inverter output with minimal delay time
- Uses the MATE3™ class of System Display and Controller products, or the AXS Port™ SunSpec Modbus Interface (sold separately) for user interface as part of a Grid/Hybrid system
 - ~ MATE3s system display is required for grid support functionality (see below)
- Supports the OPTICS RE™ online tool¹ for a cloud-based remote monitoring and control application
 - ~ Requires the MATE3 or the AXS Port
 - ~ Visit **www.outbackpower.com** to download
- Uses the HUB10.3™ Communications Manager for stacking as part of a Grid/Hybrid system
 - ~ Stackable in parallel configuration up to ten inverters
- Certified by ETL to UL 1741 SA, CSA C22.2, and IEC 62109-1
- Grid support functionality according to the requirements of UL 1741 SA
- Field-upgradeable firmware (from www.outbackpower.com); requires MATE3 product or AXS Port
 - ~ The MATE3s system display must be used when upgrading the inverter to firmware revision 001.006.063 or higher.
- Seven selectable input modes for different applications
 - ~ **Generator**
 - ~ **Support**
 - ~ **Grid Tied**
 - ~ **UPS**
 - ~ **Backup**
 - ~ **Mini Grid**
 - ~ **GridZero**



NOTE:

This product has a settable AC output range. In this book, many references to the output refer to the entire range. However, some references are made to 120/240 Vac or 60 Hz output. These are intended as examples only.

GS8048A

- 8,000 watts (8 kW) continuous power at 48 Vdc
- 16.97 kVA peak surge capacity
- Modular internal design allows low idle consumption, high efficiency at both high and low power operation

GS4048A

- 4,000 watts (4 kW) continuous power at 48 Vdc
- 8.48 kVA peak surge capacity

Inverter Controls

The Radian inverter has no external controls or display pre-installed. It can operate normally without an external control or interface. Basic modes and settings are pre-programmed at the factory. (See page 63 for default settings.) However, certain products can monitor, operate, or program the Radian. These include OPTICS RE and the MATE3 class of system display.

See the *Radian Series Inverter/Charger Installation Manual* for information on wiring a manual on/off switch.

MATE3-Class System Display and Controller

The MATE3 class of system display products (sold separately) includes the MATE3 and the MATE3s. These are designed to accommodate programming and monitoring of a Grid/Hybrid power system. The system display provides the means to adjust the factory default settings to correctly match the installation where needed. It provides the means to monitor system performance and troubleshoot fault or shutdown conditions. It also has data logging and interface functions using the Internet.

Once settings are modified using a MATE3-class device, it can be removed from the installation. The settings are stored in the nonvolatile memory of the Radian inverter. However, it is highly recommended to include a system display as part of the system. This provides the means to monitor system performance and respond quickly should it be necessary to correct a fault or shutdown condition.

In a MATE3-class device, the Profile Wizard is a guided program for rapidly configuring devices. It prevents the need for repetitive programming when multiple common devices are used. After collecting user input, it can automatically configure inverters to a series of preset values. Affected fields include system type, battery charging, and AC source configuration. 



IMPORTANT:

- ❖ The Radian inverter is only compatible with the MATE3 class of system display products. Radian revision 001.005.004 or lower can be used with any revision of MATE3s but can only be used with MATE3 revision 002.017.000 or higher. This product is not intended for use with the OutBack MATE or MATE2 products.
- ❖ A MATE3s system display with revision 001.001.000 or higher must be used when operating an FXR inverter with firmware revision 001.006.063 or higher.
- ❖ The Radian inverter can use the OPTICS RE online tool as a system display. OPTICS RE must be used in conjunction with a MATE3-class system display or with the AXS Port SunSpec Modbus Interface.
- ❖ Some functions are not based in the inverter, but are part of the system display's firmware. They will not function if the system display is removed. 



Operation

Inverter Functionality

The Radian inverter can be used for many applications. Some of the inverter’s operations occur automatically. Others are conditional or must be enabled manually before they will operate.

Most of the inverter’s individual operations and functions can be programmed using the system display. This allows customization or fine tuning of the inverter’s performance.

The Radian inverter has two sets of input connections, which are labeled **GRID** and **GEN**. Two different AC sources can be connected during inverter installation. 

Before operating the inverter:

The operator needs to define the application and decide which functions will be needed. The Radian inverter is programmed with seven AC input modes. Each mode is optimized for a particular application. Some modes contain functions unique to that mode.

The modes are described in detail following this section. To help decide which mode will be used, the basic points of each mode are compared in Table 1 on page 19.

Apart from the input modes, Radian inverters possess a set of common functions or operations. These operations are described in detail beginning on page 20. Most of these items operate the same regardless of which input mode is selected. The exceptions are noted where appropriate.

	<p>NOTE:</p> <p>The Radian’s battery charger uses the same programming and settable limits regardless of which input is used. It does not have independent charger settings on each input.</p>
---	---

Each distinct mode, function, or operation is accompanied by a symbol representing the inverter and that operation:

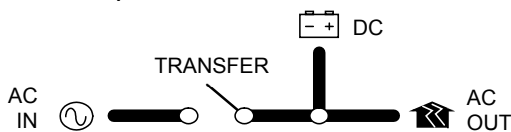

These items represent the input from the AC source, the output to the AC loads, DC functions (inverting, charging, etc.), and the transfer relay. Arrows on each symbol represent power flow.

The symbols may have other features depending on the operation.

Description of AC Input Modes

These modes control aspects of how the inverter interacts with AC input sources. Each mode is intended to optimize the inverter for a particular application. The names of the modes are **Generator**, **Support**, **Grid Tied**, **UPS**, **Backup**, **Mini Grid**, and **GridZero**. The modes are summarized and compared in Table 1. See page 19.

Both of the Radian’s inputs, **GRID** and **GEN**, can be programmed for separate modes.

- The **GRID** input can be set in the **Grid AC Input Mode and Limits** menu.
- The **GEN** input can be set in the **Gen AC Input Mode and Limits** menu.



NOTE:

- ❖ The input terminals are labeled for grid and generator due to common conventions, not because of inverter requirements. Each input can accept any AC source as long as it meets the requirements of the Radian inverter and the selected input mode. If necessary, the **GEN** terminals can accept grid power. The opposite is also true.
- ❖ However, if using the **Gen Alert** or **AGS** functions, the generator must use the **GEN** terminals. See page 39 for details on **Gen Alert** and the system display literature for details on AGS.

When multiple inverters are stacked together in parallel, the master inverter's input mode is imposed on all slaves. (See the stacking section in the *Installation Manual*.) The slave settings are not changed; they retain any mode that was previously programmed. However, the slave will ignore its programmed mode and use that of the master. This also applies to any parameters in the mode menu (**Voltage Limit**, **Connect Delay**, and so on).

The following pages compare the various features of each input mode.

Generator

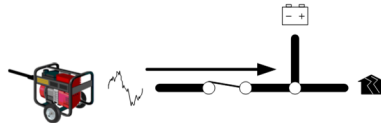

The **Generator** mode allows the use of a wide range of AC sources, including generators with a rough or imperfect AC waveform. In other modes, a “noisy” or irregular waveform may not be accepted by the inverter. (Self-excited induction generators may require this mode when used with the Radian.) **Generator** allows these waveforms to be accepted. The charging algorithm of this mode is designed to work well with AC generators regardless of power quality or regulation mechanism. The generator must still comply with the inverter's nominal input specifications. (See page 25.)

BENEFITS:

- This mode enables the battery charging function to tolerate a wider range of generator performance and waveform irregularities than other modes. See page 26 for recommended parameters for sizing a generator.
- **Generator** mode can also be used to accommodate grid variability or irregularities. The inverter will not export power to the grid in this mode.
- A programmable delay timer is available which will allow a generator to stabilize before connection. In MATE3-class system displays, this menu item is **Connect Delay**. It is available in both the **Grid AC Input Mode and Limits** and the **Gen AC Input Mode and Limits** menus, depending on which input is being programmed.

NOTES:

- Any AC fluctuations that are accepted by the inverter will be transferred to the output. The loads will be exposed to these fluctuations. It may not be advisable to install sensitive loads under these conditions.
- The name of **Generator** mode does not mean that the inverter requires a generator input when using this mode. The use of this mode does not require the use of the **GEN** input terminals; either input can be used. Conversely, the inverter is not required to be placed in this mode just because a generator is installed.

Support

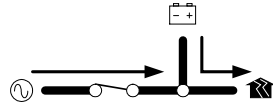

The **Support** mode is intended for systems that use the utility grid or a generator. In some cases the amount of current available from the source is limited due to size, wiring, or other reasons. If large loads are required, the Radian inverter augments (supports) the AC source. The inverter uses battery power and additional sources to ensure that the loads receive the power they demand.

In a MATE3-class system display, the **Grid Input AC Limit** dictates the maximum AC draw for the Grid input. The **Gen Input AC Limit** sets the maximum draw for the Gen input. The **Support** function takes effect if the AC demand on either input exceeds the **AC Limit** setting.

BENEFITS:

- Large inverter loads can be powered while staying connected to the AC input, even if the input is limited. The added battery power prevents overload of the input source, but the batteries are not in constant use.
- The Radian inverter will offset the loads with excess renewable energy if it is available from the batteries. See page 36 for more information on the **Offset** function.

NOTES:

	<p>IMPORTANT:</p> <p>The inverter will draw energy from the batteries when the loads exceed the appropriate AC Limit. With sustained loads and no other DC source, the batteries may discharge to the Low Battery Cut-Out point. The inverter will shut down with a Low Battery error. (See pages 21 and 51.) To prevent the loss of power, load use should be planned accordingly.</p>
	<p>IMPORTANT:</p> <p>A “noisy” or irregular AC source may prevent Support from working normally. The inverter will transfer the power, but will not support the source, charge the batteries, or interact with the current in any other way. This problem is more common with generators smaller than the wattage of the inverter.</p>

- Because the inverter limits the current draw from the AC source, it will reduce the charge rate as necessary to support the loads. If the loads equal the appropriate **AC Limit** setting, the charge rate will be zero.
- If the AC loads exceed the AC Limit setting, the Support function is activated. Instead of charging, the inverter will take power from the batteries and use it to support the incoming AC current.
- The **Support** function is not available in any other input mode.

Grid Tied

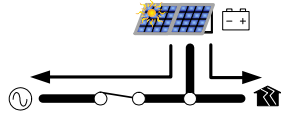

IMPORTANT:

Selling power to the utility company requires the authorization of the local electric jurisdiction. How the utility company accommodates this will depend on their policies on the issue. Some may pay for power sold; others may issue credit. Some policies may prohibit the use of this mode altogether. *Please check with the utility company and obtain their permission before using this mode.*

The **Grid Tied** mode allows the Radian inverter to become grid-interactive. This means that in addition to using power from the utility grid for charging and loads, the inverter can also convert excess battery power and sell it to the utility grid. Excess battery power usually comes from renewable energy sources, such as PV arrays, hydroelectric turbines, and wind turbines.

- The grid-interactive function uses **Offset** operation. See page 36 for more information.
- The grid-interactive function utilizes the **Grid Support** settings. See page 37 for more information.

BENEFITS:

- Excess power is returned to the utility grid.
 - ~ The inverter will offset the loads with excess renewable energy if it is available from the batteries.
 - ~ If the excess energy is greater than the AC (load) demand, the excess will be sold to the grid.

NOTES:



- The inverter has a delay before selling will begin. This function, the **Re-Connect Delay Timer**, has a default setting of five minutes. *During this time, the inverter will not connect to the utility grid.* The timer is adjustable in the **Grid Interface Protection** menu (see below).
- Upon initial connection to the utility grid, the inverter may be required to perform a battery charging cycle. This may delay the operation of the grid-interactive function.
- The grid-interactive function only operates when excess DC (renewable) power is available.
- The grid-interactive function is not available in any of the other input modes.
- Whenever energy produced from the renewable energy source exceeds the loads on the inverter output, the system display will indicate selling. Any power not consumed by loads on the main panel will be sold to the grid.
- The amount of power an inverter can sell is not necessarily equal to its specified output wattage. The **Maximum Sell Current** can be decreased if it is necessary to limit the power sold. This item is available in the **Grid Interface Protection** menu (see next page). This setting is not affected by the **AC Limit** settings (see page 24).
 - ~ The amount of power sold is controlled by the utility grid voltage. The wattage sold equals this voltage multiplied by the current. For example, if the inverter sells 30 amps and the voltage is 231 Vac, the inverter will sell 6.93 kVA. If the voltage is 242 Vac, the inverter will sell 7.26 kVA. Additionally, output will vary with inverter temperature, battery type, and other conditions.
 - ~ This recommendation is specifically for the inverter's grid-interactive function. In some cases, the source may be sized larger to account for environmental conditions or the presence of DC loads. This depends on individual site requirements.

Grid Interface Protection Menu

Grid-interactive requirements vary in different locations around the world. The grid-interactive settings are adjustable in the **Grid Interface Protection** and **Grid Support** menus. These menus are only available with installer-level access. These settings are generally controlled by the local authorities or interconnection agreement and should not be altered by the end user.

The installer password must be changed from the default to access these settings. Once it has been changed, the settings can only be accessed with the installer password. 

This menu includes the following:

- **Operating Frequency.** It can be selected to either 50 or 60 Hz. This setting changes the inverter's output frequency, but it also changes the input (and grid-interactive) acceptance parameters. See page 22 for more information on the inverter's frequency.
 - **Clearance Time** during power loss.
 - **Maximum Sell Current** when exporting power to the utility.
 - The **Grid Support** menu contains multiple voltage, frequency and time parameters for operation. The grid-interactive function can only operate while the grid is stable and within specific limits.
 - ~ In **Grid Tied** mode, the inverter operates in accordance with the **Grid Support** settings. If the AC voltage or frequency vary outside these limits, the inverter will disconnect to isolate itself and its protected loads. **Grid Support** settings adhere to specific standards, such as California's Rule 21 or HECO Rule 14H. These limits override the AC source acceptance limits on page 25, which are used in most other modes. See page 37 for more information on the **Grid Support** function.
 - ~ Before operating in **Grid Tied** mode, be sure to obtain any necessary interconnection agreements or related documents from the utility company or local building authority. These documents will typically specify the grid support and interface protection settings that must be used for that installation.
 - ~ The **Grid Support** menu has a **Regulatory Specification** screen that displays the standard currently loaded on the system and the settings loaded into the **Grid Support** options from a .GIP file. (See below.) The default standard (and settings) is **IEEE 1547**.
 - ~ The items in the following list are the selectable **Grid Support** options. The utility company may need to review these items to make certain their standards are met.
 - **Low and High Voltage and Frequency Ride-Through**
 - **Fixed Power Factor**
 - **Ramping**
 - **Frequency Watt**
 - **Volt Watt**
 - **Volt/VAr**
- If the grid is outside the parameters of the applicable standard, the inverter disconnects from the AC source. It will not reconnect until the source meets the voltage and frequency **Reconnect Parameters** for the duration of the timer in that menu.
- ~ If the inverter stops selling or disconnects due to **Grid Interface Protection**, the system display will show the reason. **Sell Status** messages are listed on page 55. **Disconnect** messages are listed on page 54. Often these messages will be the same.
 - **Upload Grid Protection.** This screen automatically loads a "package" of grid support settings from a .GIP file. See the *Radian Series Inverter/Charger Installation Manual* for instructions. 
 - See Table 17 beginning on page 63 for the locations and settings of all menu items in MATE3-class system display menus, including those on this page. 

Operation

UPS

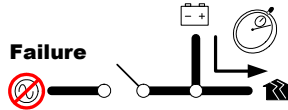

In **UPS** mode, the Radian's parameters have been optimized to reduce the response time. If the utility grid becomes unstable or is interrupted, the Radian can transfer to inverting with the fastest possible response time. This allows the system to support sensitive AC loads without interruption.

BENEFITS:

- Constant power is provided to the loads with virtually no drop in voltage or current.

NOTES:

- Due to the need for the Radian inverter to react quickly to AC source fluctuations, it must remain fully active at all times. The inverter requires a continuous consumption of 42 watts.
- For this reason, the **Search** function does not operate in this mode. (See page 23.)

Backup

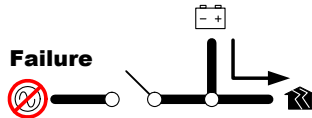

The **Backup** mode is intended for systems that have utility grid available as the primary AC source. This source will pass through the Radian inverter's transfer circuit and will power the loads unless utility power is lost. If utility grid power is lost, then the Radian inverter will supply energy to the loads from the battery bank. When the utility power returns, it will be used to power the loads again.

BENEFITS:

- This mode will continuously maintain the batteries in a fully-charged state, unlike the **Support** mode. It does not have the overhead consumption of the **UPS** mode.

Mini Grid

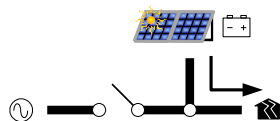

In **Mini Grid** mode, the Radian inverter automatically rejects an AC source and runs solely from battery (and renewable) energy. The inverter only connects to the AC source (usually the utility grid) when the batteries run too low.

The inverter runs on battery-supplied power for as long as the batteries can be sustained. It is expected that the batteries will also be charged from renewable sources such as PV. When the batteries become depleted, the system reconnects to the utility grid to operate the loads.

The inverter will reconnect to the utility grid if the battery voltage decreases to the **Connect to Grid** set point and remains there for the **Delay** time period. These items are shown in Table 17 on page 63.

While connected to the utility grid, the inverter's charger can be set either On or Off. If the charger is turned on, the inverter will proceed through a full charging cycle. Upon reaching the end of the charging cycle, the inverter will disconnect from the grid.

If the inverter is connected to the utility grid and the charger is turned off, another source such as renewable energy should be present to charge the batteries. The inverter will observe the batteries as if it was charging. When the batteries reach the required voltage and time to end the cycle, the inverter will disconnect from the grid. This means that the renewable source regulator settings must be the same as the inverter (or higher). Check both settings as needed.



See page 26 for more information on the battery charging cycle.

BENEFITS:

- **Mini Grid** mode allows a system to minimize or eliminate dependence on the utility grid. This is only possible if certain conditions are met. See below.

NOTES:

- The Radian inverter will offset the loads with excess renewable energy if it is available from the batteries. See page 36 for more information on **Offset** operation. However, **Offset** is inapplicable when the Radian disconnects from an AC source. The renewable energy supports the inverting function instead.
- This mode has similar priorities to the high-battery transfer (**HBX**) function used by a MATE3-class system display. However, it is not compatible with **HBX** and cannot be used at the same time. When using **Mini Grid** mode, the user should disable **HBX** to prevent conflicts.

Mini Grid mode is also incompatible with the system display **Grid Use Time** and **Load Grid Transfer** functions. These functions do not have similar priorities to **Mini Grid** or **HBX**, but they do control the inverter's grid connection and disconnection. **Mini Grid** should not be used with these functions.

- When deciding whether to use **Mini Grid** mode or **HBX**, the user should consider aspects of each.
 - ~ **Mini Grid** logic is based in the Radian inverter and can function in the absence of the system display. **HBX** logic is based in the system display. It cannot function unless the system display is installed and operating.
 - ~ **Mini Grid** can use utility grid power to fully recharge the batteries every time it reconnects to the grid. **HBX** can only do so under specific circumstances.
 - ~ **HBX** set points have a wide range of settings. **Mini Grid** uses settings which protect the batteries from excessive discharge; however, most settings are automatic and do not allow customization.
 - ~ **HBX** works more efficiently with a larger renewable source, but there is no specification for renewable size. **Mini Grid** cannot work properly unless the renewable source is larger than the loads. If this condition is not met, **Mini Grid** will not disconnect the inverter from the grid.
 - ~ **Mini Grid** is one of seven inverter-level functions (modes) which share a single input. Selecting it prevents any other input mode from being used. **HBX** is a system-level function which can be combined with the settings of other input modes.
 - ~ See the system display literature for more information on **HBX** mode, **Grid Use Time**, and **Load Grid Transfer**.



GridZero

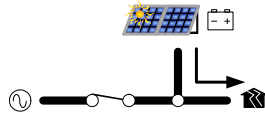

In **GridZero** mode, the Radian inverter remains grid-connected, but prioritizes the use of battery or renewable sources to run loads. It uses only renewable energy to recharge the batteries. The inverter tries to “zero” the grid use, drawing on AC power only when needed to supplement stored DC sources. Note that the inverter draws up to 1 Aac regardless of the DC sources.

In a MATE3-class system display, the selectable options are **DoD Volts** and **DoD Amps**. Any time the batteries exceed the **DoD Volts** setting by 0.8 Vdc, the Radian will send power from the batteries to the loads. As the battery voltage decreases to the **DoD Volts** setting, the inverter will reduce the rate of flow toward zero. It will maintain the batteries at this setting.

The Radian inverter can manage large quantities of power. To prolong cycle life and increase battery capacity, the rate of discharge can be limited using the **DoD Amps** setting. This item should be set lower than the current provided by the renewable source.

- When **DoD Volts** is set low, this mode allows more renewable energy to be delivered from the batteries to the loads. However, it will also leave less battery reserve in the event of a grid failure.
- When **DoD Volts** is set high, the batteries will not be discharged as deeply and will retain more of a backup reserve. However, not as much renewable energy will be sent to the loads.

The renewable energy source needs to exceed the energy demand of all loads and possible losses. The renewable source must also charge the batteries. The inverter does not charge the batteries in **GridZero** mode.

BENEFITS:

- This mode seamlessly blends the use of battery power and grid power. It puts renewable energy to the most effective use without selling power to the utility grid.
- **GridZero** mode minimizes dependence on the grid as long as certain conditions are met.
- The inverter remains connected to the utility grid in case the grid is needed. If large loads require the use of grid power, no transfer is necessary to support the loads.
- This mode utilizes the **Grid Support** settings. See page 37 for more information on this function.

NOTES:



IMPORTANT:

Setting **DoD Volts** too low will severely discharge the batteries. The battery bank may not have sufficient reserve to provide backup in the event of a grid failure. To prevent the loss of power, load use and the **DoD Volts** setting should be planned accordingly.

- If the renewable energy source is not greater than the size of the inverter loads, this mode will not work well over time. The renewable source must be capable of charging the batteries as well as running the loads. This occurs when renewable energy production exceeds the **DoD Amps** setting.
- The inverter will offset the loads with excess renewable energy if it is available from the batteries. See page 36 for more information on **Offset** operation. However, the behavior of **Offset** in GridZero mode is different because it uses the **DoD Volts** exclusively.
- The inverter’s battery charger cannot be used in this mode. However, the charger menu settings and timer operations are not changed when this mode is selected.
- The battery should be discharged whenever possible in the attempt to “zero” the grid usage. If the DoD Amps setting (or load demand) is too low, the renewable source will be prematurely curtailed. The system will be unable to use the renewable energy and will then be more dependent on the grid. The **DoD Amps** setting should be raised periodically until the renewable energy is fully utilized.

Table 1 Summary of Input Modes

Mode	Summary	Benefits	Cautions	Intended	Charger
Generator	Accepts power from an irregular or low-quality AC source	<ul style="list-style-type: none"> • Can use AC that may be unusable in other modes • Can charge even with poor generator or low-quality AC source 	<ul style="list-style-type: none"> • Will pass irregular or low-quality power to the output; could damage sensitive loads • Offset unavailable 	Source: Generator Loads: Non-sensitive devices	Performs three-stage charge and goes silent as specified by settings.
Support	Adds battery power to augment an AC source that has limited output	<ul style="list-style-type: none"> • Can use battery power in conjunction with AC source • Offset operation sends excess DC to loads 	<ul style="list-style-type: none"> • Drains batteries during support; intended for intermittent use only • May not function with low-quality AC source 	Source: Grid or Generator Loads: Can be larger than AC source	Performs three-stage charge and goes silent as specified by user settings.
Grid Tied	Inverter sells excess power (renewable) to utility	<ul style="list-style-type: none"> • Bidirectional input • Can reduce utility bills and still provide backup • Offset operation sends excess DC to loads • Any additional Offset excess is sold to the grid 	<ul style="list-style-type: none"> • Requires utility approval • Other approvals may be required depending on electrical codes • Has exact requirements for accepting AC input • Requires renewable energy source 	Source: Grid Loads: Any type	Performs three-stage charge and goes silent as specified by user settings.
UPS	In grid failure, unit switches to batteries with fastest possible response time	Quick backup for sensitive devices during grid outage	<ul style="list-style-type: none"> • Uses higher idle power than other modes • Search function unavailable • Offset unavailable 	Source: Grid Loads: PC, audio, video, etc.	Performs three-stage charge and goes silent as specified by user settings.
Backup	In grid failure, unit switches batteries to support loads	<ul style="list-style-type: none"> • Simple use compared to other modes; often used with generators for this reason • Less idle power than UPS • Does not drain battery as in Support 	Has none of the special functions described in other modes	Source: Grid or Generator Loads: Any type	Performs three-stage charge and goes silent as specified by user settings.
Mini Grid	Stays off grid most of the time; only uses grid when batteries low	<ul style="list-style-type: none"> • Can minimize/eliminate dependence on grid • Offset operation sends excess DC to loads (but only when on grid) 	<ul style="list-style-type: none"> • Will not work properly unless renewable source is above a certain size • Conflicts with related modes in system display 	Source: Grid Loads: Any type	Performs three-stage charge on reconnect; if charger is disabled, inverter emulates charge cycle from external source and reacts accordingly
Grid Zero	On-grid but actual grid use is “zeroed out” with battery and renewable power; does not sell or charge	<ul style="list-style-type: none"> • Can minimize/eliminate dependence on grid • Offset operation sends excess DC to loads at adjustable rate • Remains on-grid to avoid transfer problems 	<ul style="list-style-type: none"> • Discharges batteries while remaining on grid • Will not work properly unless renewable source is above a certain size • Battery charger inoperative 	Source: Grid Loads: Any type	Charger inoperative; batteries must be charged using an external (renewable) energy source

Description of Inverter Operations

The items in this section are operations common to all Radian inverters. These are used in most or all of the input modes described in the preceding section.

Some of the items in this section are functions which can be manually selected, enabled, or customized. Other items are general topics or applications for the inverter. These items may not have their own menus, but their activity can still be influenced or optimized by changing certain settings.

Any of these items may need to be adjusted so that the inverter is best matched to a particular application. The operator should review these items to see which are applicable.

All items described as settable or adjustable have set points which can be accessed  using the system display. The default settings and ranges of adjustment are listed in Table 17 beginning on page 63 of this manual.

Inverting

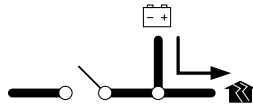

This is the Radian inverter's primary task. The inverter converts DC voltage from batteries into AC voltage that is usable by AC appliances. It will continue to do this as long as the batteries have sufficient energy. The batteries can be supplied or recharged from other sources, such as solar, wind, or hydroelectric power.

The inverter's design uses transformers and high-frequency H-Bridge FET modules to achieve the required high-wattage output. In the GS8048A, the dual design allows half the inverter to shut down for lower idle consumption when not in use.

The Radian can deliver the rated wattage continuously at 25°C. The maximum output is derated at temperatures exceeding 25°C. See pages 57 and 59 for these wattages.

Measure the total load wattage so that it does not exceed the Radian's capacity. The Radian cannot maintain its AC voltage under an excessive load. It will shut down with a **Low Output Voltage** error.



IMPORTANT:

- ❖ The Radian inverter cannot support severe output load imbalance. The GS8048A can maintain no more than 4 kVA continuously on either the L1 or L2 output, regardless of the load on the other output. For example, it cannot maintain 8 kVA on L1, even if the load on L2 is 0.
- ❖ Similarly, the GS4048A can maintain only 2 kVA on a single output, regardless of the state of the other output.
- ❖ Any greater loads (at 25°C) will cause a **Low Output Voltage** error.

DC and AC Voltages

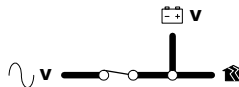

The Radian inverter requires batteries to operate. Other sources may not maintain DC voltages that are consistent enough for the inverter to operate reliably.



CAUTION: Equipment Damage

Do not substitute other DC sources in place of the batteries. High or irregular voltages may damage the inverter. It is normal to use other DC sources with the batteries and the inverter, but not in place of the batteries.

Operation

The following items will affect the inverter's operation. These are only used when the inverter is generating AC power on its own.

- **Low Battery Cut-Out:** This function prevents the inverter from draining the batteries completely. When the DC voltage drops below a specified level for 5 minutes, the inverter will stop functioning. The system display will give a **Low Battery V** error. This is one of the error messages on page 51. It appears as an event on a MATE3-class system display. 
This function is intended to protect both the batteries and the inverter's output. (Continuing to invert on a low DC voltage may produce a distorted waveform.) This item is adjustable.
- **Low Battery Cut-In:** The recovery point from **Low Battery Cut-Out**. When the DC voltage rises above this point for 10 minutes, the error will clear and the inverter will resume functioning. This item is adjustable.
 - ~ Connecting an AC source for the inverter to charge the batteries will also clear a low battery error.
- **Output Voltage:** The AC output voltage can be adjusted. Along with small changes, this allows the inverter to be used for different nominal (split-phase) voltages such as 100/200 Vac and 120/240 Vac.



IMPORTANT:

The output voltage can be adjusted to a different nominal value for a particular region. Making this change will not affect the default input voltage range accepted by the inverter from an AC source. The input range must be adjusted manually. These changes should be made at the same time. (See **AC Source Acceptance** on page 25.)

- The inverter is also controlled by a high battery cut-out limit. If the DC voltage rises above this limit, the inverter will immediately stop functioning and give a **High Battery V** error. This function is intended to protect the inverter's output and loads. Continuing to invert on a high DC voltage may produce a distorted waveform. Note that the inverter's high battery cut-out does not alleviate the high battery state. The cause is an external condition which could damage the inverter.
 - ~ For the Radian inverter, the high battery cut-out voltage is 68 volts. It cannot be changed.
 - ~ If the voltage drops below this point, the inverter automatically recovers.
 - ~ This is one of the errors on page 55. It appears as an event on a MATE3-class system display.



AC Frequency

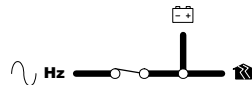

CAUTION: Equipment Damage

Setting the inverter's output frequency to deliver 50 Hz to 60-Hz loads, or setting it to deliver 60 Hz to 50-Hz loads, could damage sensitive devices. Make certain the inverter's output frequency matches the installation.

The inverter's output can operate at a frequency of either 60 or 50 Hertz. This output frequency (and the AC acceptance frequency) can be changed with the **Operating Frequency** menu item. This requires high-level access. Due to the possibility of damage, access to this setting has been restricted by placing it in the **Grid Interface Protection** menu. See page 15 for more information. See Table 17, which begins on page 63, for the location of the **Operating Frequency** menu item.

The installer password must be changed from the default in order to get access to this menu. Once this password has been changed, the **Grid Interface Protection** menu can only be accessed by using the installer password. This password can be changed in the system display. 

Search

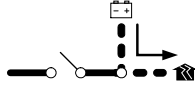

An automated search circuit is available to minimize the power draw when no loads are present. When enabled, the inverter does not always deliver full output. The output is reduced to brief pulses with a delay between them. These pulses are sent down the output lines to see if a resistance is present. Basically, the pulses “search” for a load. If a load is detected on the output, the inverter’s output increases to full voltage so that it can power the load. When the load is turned off, the inverter “goes to sleep” and begins searching again.

Search mode sensitivity is adjusted with the **Sensitivity** menu item. See Table 17, which begins on page 63, for the location of this item. The sensitivity is adjusted in small increments which are measured in fractions of one ampere.



NOTE:

Increment sizes are difficult to define due to varying load characteristics. However, the default setting, 10 increments, is *approximately* sufficient to detect the load of one compact fluorescent light (CFL). A load which draws this amount or greater will “wake up” the inverter.

- **Search** mode is not particularly useful with loads requiring continuous power. (These loads include clocks, answering machines, and similar devices.) “Sleep” operation with these loads simply results in a power interruption or nuisance shutdown.
- **Search** mode may not be useful with loads that are critical or are intentionally operated a large portion of the time even if they are not continuous. (These loads include computers and similar devices.) The inverter may “sleep” so rarely that the mode has no benefit.
- Some devices may not be easily detected by **Search** mode.
- **Search** is inoperative if the **UPS** input mode is in use. See page 16 for more information.

Search mode is ideal for use in small systems where it is critical to conserve battery capacity and avoid idle draw or “ghost” loads.

To set up Search mode for use:

1. Turn off all loads.
2. Activate **Search** mode with the system display.
3. Determine the smallest load that is to be used and turn it on.
4. If the load operates, the inverter is active and is producing power. No further adjustments are needed.
5. If the inverter does not produce power and continues to “sleep”, the sensitivity is set too high. Turn the load off and lower the **Sensitivity** menu item. Turn on the load and test whether the inverter activates.
6. Repeat step 5 as needed until turning on the load also reliably activates the inverter.

The pulse duration and the delay both have a time period that is measured in AC cycles. These two items, **Pulse Length** and **Pulse Spacing**, are adjustable in the same menu as **Sensitivity**. If **Sensitivity** does not achieve the desired results, it may be useful to perform similar adjustments on these items.

Input

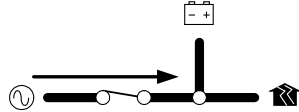

When the Radian inverter input terminals are connected to a stable AC source, the inverter will synchronize itself with that source and use it as the primary source of AC power. Its transfer relay will engage, linking the AC source directly with the inverter's output. It can also use the source to charge batteries. (See **Battery Charging** on page 26.)

- The loads powered by the inverter **must not** exceed the size of the inverter's transfer relay.



CAUTION: Equipment Damage

Current draw in excess of the transfer relay rating can damage the transfer relay. This damage is not covered by warranty. Use protective devices of appropriate size.

- Two sets of AC input terminals are available. Both inputs are identical and can be used for any AC source. However, for easy reference, the first input has been labeled **GRID** (for the utility grid). The second input is labeled **GEN** (for a generator). These designations are also used in the menus of a MATE3-class system display.
 - ~ Each input has a separate set of input criteria and input modes.
 - ~ The criteria, modes, and other programming for each input contain identical content.
- The independent inputs are intended to simplify the connection to multiple AC sources; however, the inverter can only use one input at a time. If both inputs are powered, the default setting is for the inverter to accept the **GRID** input. This can be changed. In a MATE3-class system display, these priorities are selected using **Input Priority** in the **AC Input and Current Limit** menu.
- The interactions with AC input sources are controlled by the various input modes. The **Grid Tied** mode allows certain models to sell power using the input connection. The **Support** mode can use battery power to assist a smaller AC source. When **GridZero** mode is selected, the battery charger cannot be used. See page 19 for descriptions of these and other input modes.

AC Current Settings

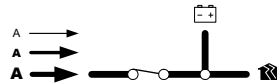

The AC current settings, **Grid Input AC Limit** and **Gen Input AC Limit**, control the amount of current that the inverter draws from the source(s). When using either of the Radian's AC inputs, the appropriate setting limits the input. Adjust these settings to match the input circuit breakers.

- The adjustment is meant to protect a generator or source that cannot supply enough current for both charging and loads. If the combined charging and loads exceed the setting, the inverter will reduce its charge rate and give priority to the loads. If the loads exceed this number on their own, the charge rate will be reduced to zero.
- The **AC Limit** settings can limit the charging current, although the charger has an individual setting. (See page 27.) Note that this does not limit the current sold in **Grid Tied** mode. (See page 14.)
- The **GridZero** input mode requires the inverter to use DC sources, limiting the amount of AC current used. See page 18.
- The **Support** input mode allows the Radian to support the AC source with battery power. See page 13.
- The AC input current is used to power both loads and battery charging. The combined amount should not exceed the size of the AC overcurrent device or AC source. These devices should be sized appropriately during planning and installation of the inverter system. 
- If multiple parallel inverters are installed with an AC source of limited amperage, the total combined amperage settings for all units must be less than the AC input circuit. The Profile Wizard in a MATE3-class system display can perform this calculation. However, the inverters do not perform this calculation. If the system display or the Profile Wizard are not used, divide the input size by the number of inverters and assign an equal part of the amperage to each port.

AC Source Acceptance

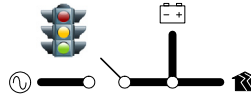

The input source must meet the following specifications to be accepted. This is true in all modes except **Grid Tied**:

- Voltage (**GRID** input): 108 to 132 Vac (default for both L1 and L2)
- Voltage (**GEN** input): 108 to 140 Vac (default for both L1 and L2)
- Frequency (both inputs): If the output frequency is set to 60 Hz (default), the input acceptance range is 54 to 66 Hz. If output frequency is set to 50 Hz, the input range of acceptance is 45 to 55 Hz.
- See Table 17 on page 63 for the available selections for these items.

When these conditions are met, the inverter will close its transfer relay and accept the input source. This occurs after a delay which is specified below. If the conditions are not met, the inverter will not accept the source. If it was previously accepted and then rejected, the inverter will open the relay and return to inverting power from the batteries. This occurs after a specified transfer delay, which is an adjustable menu item.



IMPORTANT:

The Radian's output voltage can be adjusted to a different nominal value for a particular region. (See page 23.) If this occurs, the source acceptance range should be adjusted to match this nominal value or the inverter may not accept the new source normally.

- The voltage limits can be adjusted to allow (or exclude) a source with weak or irregular voltages. These items are adjustable in a MATE3-class system display (**Grid AC Input Mode and Limits** or **Gen AC Input Mode and Limits**). The settings are titled **Voltage Limit Lower** and **Upper**. When adjusted, they apply equally to L1 and L2. There can be side effects to changing the range of allowed voltages.
- Each of the AC inputs has a settable **Connect Delay**. This is intended as a warmup period which allows an input source to stabilize before connection.
 - ~ The default setting for the **GRID** input is 0.2 minutes (12 seconds).
 - ~ The default setting for the **GEN** input is 0.5 minutes (30 seconds).

These items are adjustable in the appropriate system display menu (**Grid AC Input Mode and Limits** or **Gen AC Input Mode and Limits**).

NOTES:

The **Grid Tied** input mode does not use these voltage, frequency and time acceptance limits. It uses the **Grid Interface Protection** and **Grid Support** settings instead. (See pages 16 and 43 for more information.) The inverter may not accept AC power if it meets the settings noted here but does not meet the settings in these two menus.

- AC acceptance is controlled separately between the Radian inverter's two inputs. An AC source that is unacceptable on one input may be acceptable on the other if the mode or settings are different.
- Certain input modes such as **Mini Grid** may prevent the inverter from accepting AC power even if electrical conditions are met. (See page 16.)

Several items external to the inverter may prevent the inverter from accepting AC power even if electrical conditions are met. Some examples are the **High Battery Transfer**, **Grid Usage Time**, or **Load Grid Transfer** functions, all of which are operated by the system display. Another example is the **AC INPUT** hot key menu of a MATE3-class system display, which can order all inverters to disconnect when set to **Drop**. 

Generator Input

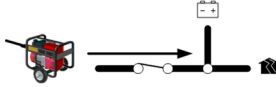

A generator should be sized to provide enough power for all inverters, both for loads and for battery charging. The generator's voltage and frequency must match the Radian inverter's acceptance settings. Some generators may not be able to maintain AC voltage or frequency for long periods of time if they are loaded more than 80% of rated capacity.

The generator is required to have a stable output before its power is accepted by the inverter. Some generators with less stable or uneven outputs may not be accepted. The use of the **Generator** input mode may assist with this problem.

If a smaller generator must be used, the **Support** input mode may be able to provide support to the loads from the batteries during peak load times. The inverter can recharge the batteries during non-peak times.

Transfer

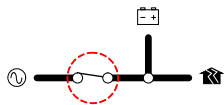

The inverter uses a transfer relay to alternate between the states of inverting and of accepting an AC source. Until the relay energizes, the output terminals are electrically isolated from the input that is in use. When it closes, the input and output terminals become electrically common. (The terminals for the unused input remain isolated during this time.) When the relay changes states, the physical transfer delay is *approximately 25 milliseconds*.



CAUTION: Equipment Damage

Current draw in excess of the transfer relay rating can damage the transfer relay. This damage is not covered by warranty. Use protective devices of appropriate size.

The relay contacts are limited to 50 amps per phase or leg. The continuous loads on that output should never exceed this number. When connected to an AC source, the Radian inverter cannot limit the load current. An overload condition is possible.

The inverter does not filter or actively condition the AC source. The voltage and power quality received by the output loads is the same as that of the source. If the voltage or quality do not meet the inverter's input requirements, it will disconnect and return to the inverting mode.

NOTES:

- To ensure a smoother transition, it may be advisable to raise the inverter's lower acceptance limit. The default setting is 108 Vac on both the L1 and L2 input lines. A higher setting will cause the inverter to transfer sooner in the event of a quality problem.
- If the AC source meets the inverter's requirements but is irregular, any fluctuations will be transferred to the loads. If the loads are sensitive, it may be necessary to improve the quality of the AC source.
- The **Generator** input mode is intended to accept irregular or unfiltered AC sources and is more likely to do so than other modes. This should be considered before using this mode with sensitive loads. (See page 12.)

If the charging function is turned off, the inverter will transfer power from the source but will not use it to charge. If the inverting function is turned off, the inverter will transfer ("pass through") the source power when connected, but will not invert when the source is removed.

In a stacked system, slaves are ordered to transfer at the same time as the master. If a slave does not sense an AC source at the same time as the master, it will experience a **Phase Loss** warning (see page 52). This appears as an event on a MATE3-class system display.

NOTE: A slave in **Phase Loss** will continue supporting the master inverter's output.

Battery Charging

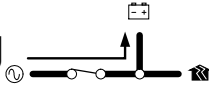

IMPORTANT:

Battery charger settings need to be correct for a given battery type. Always follow battery manufacturer recommendations. Making incorrect settings, or leaving them at factory default settings, may cause the batteries to be undercharged or overcharged.

Charge Current

Batteries or battery banks usually have a recommended limit on the maximum current used for charging. Often this is calculated as a percentage or fraction of the battery capacity, represented by “C”. For example, C/5 would be a DC amperage figure that is 1/5 of the total amp-hours of the bank.

Any chargers must be set so that the peak charge current does not exceed the recommended maximum. If multiple chargers are present (including other chargers besides the Radian), this calculation must accommodate the total combined current. The Radian’s charger may need to be set at less than maximum. The system display can be used to change charger settings.



IMPORTANT:

Although the recommended current is generally represented in DC amperes (Adc), the **Charger AC Limit** setting is measured in AC amperes (Aac), which use a different scale. To convert the recommended DC current into a usable AC figure, divide the DC figure by 4 and round up. The result can be used as a charger setting for the Radian inverter.

Examples:

1. Bank consists of 8 x L16 FLA batteries in series. Recommended maximum charge current is 75 Adc.
 $75 \div 4 = 18.75$ or 19 Aac.
2. Battery bank consists of 12 x OutBack EnergyCell 200RE VRLA batteries in series/parallel. Recommended maximum charge current is 90 Adc.
 $90 \div 4 = 22.5$ or 23 Aac.

The maximum DC charge rate for Radian models is specified in Table 12 on page 57. The actual **Charger AC Limit** setting is available in the **AC Input and Current Limit** menu of a MATE3-class system display. See Table 17 on page 63. These numbers are also summarized in Table 2 below. **NOTE:** This table does not match the calculations above due to other factors in charging.

Table 2 Charge Currents for Radian Models

Model	Maximum DC Output (sent to battery)	Maximum AC Input (used from source)
GS8048A	115 Adc	30 Aac
GS4048A	57.5 Adc	15 Aac

Charge Current for Multiple Inverters

If Radian inverters are stacked, the master inverter **Charger AC Limit** setting is used by all other inverters. Divide the total AC current by the number of chargers used and program the master with the result. The master will operate all chargers with this setting to achieve the maximum total charge current. The system display has a global **Charger Control** command of **On** which enables all available chargers.

Limiting Charge Current (Multiple Inverters)

It is not advisable to set **Charger AC Limit** less than 12 Aac in a stacked system. The Power Save function requires the master inverter to activate the slave chargers in sequence only when the charge current exceeds 11 Aac. If the setting is less than 12, Power Save will not activate any other chargers.

For more information on this function, see the **Power Save** section in the *Installation Manual*.

In some systems, lower currents may be required due to battery bank size or other reasons. To achieve lower currents, chargers can be individually set to **Off** so that the master inverter does not activate them.

For the location of the **Charger Control** command, see the menu tables beginning on page 63.

For more information on controlling the charger limits in a stacked system, see page 61.

Charge Cycle

The Radian inverter uses a “three-stage” battery charging process with Bulk, Absorption, and Float stages. These stages follow a series of steps, which are shown on graphs and described beginning below. The inverter’s factory default settings are intended for three-stage charging of lead-acid batteries.

Charging Graphs

Figure 2 shows the progression of steps of the three-stage charging cycle.

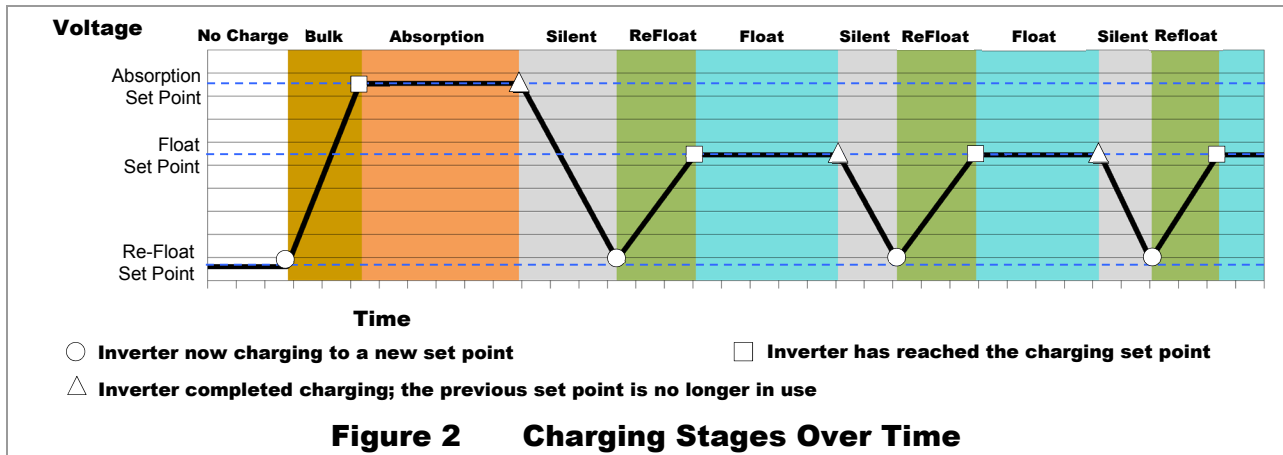
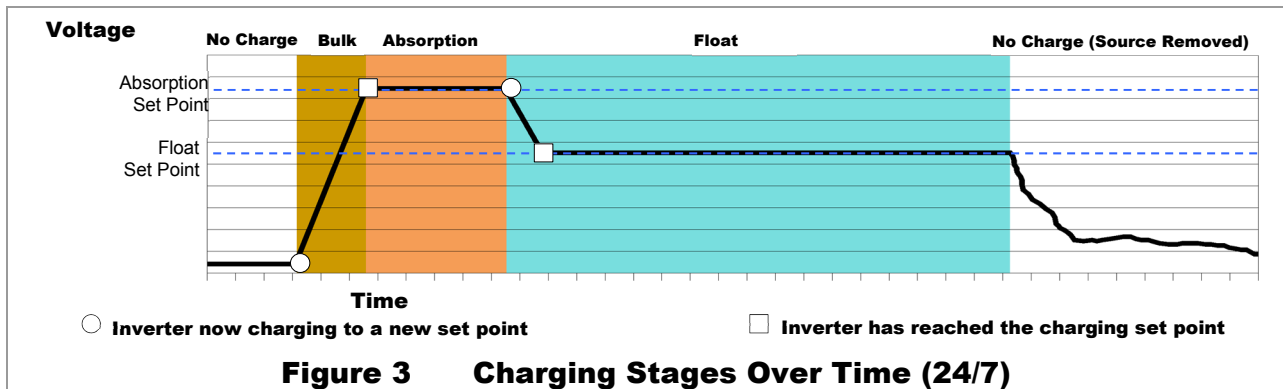

Figure 3 shows the charge cycle used by the inverter when the **Float Time** menu item is set to **24/7**. This setting eliminates the Silent and ReFloat steps. The charger remains in Float continuously. The Float stage lasts until the AC source is removed.



Advanced Battery Technologies

Advanced battery technologies such as lithium-ion and sodium-sulfur may require very different settings from the inverter's defaults or the three-stage cycle in general. The **Charging Steps** section describes the individual selections and behavior. All charger settings are adjustable for different priorities. For example, the Float voltage could be set higher than the Absorption voltage, or a step could be completely skipped.

Charging Steps

The following items describe the operation and intended use for each individual charging step as shown in the graphs. Note that some charging cycles may not follow this exact sequence. These include cycles which were previously interrupted, and also customized charging. Each step describes how to defeat or customize the step if specialized charging is required.

See page 31 for a description of multiple cycles when the charger is restarted after completion. This page also describes multiple cycles when the charger is restarted after being interrupted.

For multiple inverters:

The charging of stacked inverters is synchronized and is governed by the master inverter. The voltage settings of all other inverters are ignored. Slave inverters use the master settings.

No Charging

If the inverter is not charging, several conditions may apply:

- The unit is not connected to a qualified AC source. If a generator is present, it may not be running.
- The unit is connected to an AC source but the charger has been turned off.

Bulk Stage

This is the first stage in the three-stage charge cycle. It is a constant-current stage which drives the battery voltage up. This stage typically leaves the batteries at 75% to 90% of their capacity, depending on the battery type, the exact charger setting, and other conditions.

Voltage Used: *Absorb Voltage* setting. The default setting is 57.6 Vdc.

The initial DC current may be as high as the charger's maximum current, depending on conditions. The current will begin at a high level, but will tend to drop slightly as the voltage rises. This is not a reduction in charging. It can be viewed as a wattage "tradeoff". The actual kilowatts used by the charger are shown in the *Inverter* menu. The reading is usually consistent at this stage. (See page 43.)

To skip this step: Setting *Absorb Voltage* equal to *Float Voltage* causes the charger to proceed through the normal three-stage cycle, but at a single voltage. Setting *Absorb Time* to 0 causes the charger to skip both the Bulk and Absorption stages and proceed directly to the constant-current Refloat stage. This may not be desired if the intent is to include the Bulk stage but skip Absorption.

Absorption Stage

This is the second stage of charging. It is a constant-voltage stage. Current varies as needed to maintain the voltage, but will typically decrease to a very low number over time. This "tops off the tank", leaving the batteries at essentially 100% of capacity.

Voltage Used: *Absorb Voltage* setting. This setting is also used by *Offset* when in this stage. (See page 36.) For the three-stage cycle to proceed normally, this setting should be kept higher than the *Float Voltage* and *Re-Bulk Voltage* settings.

Operation

Time limit: **Absorb Time** setting. The charger does not necessarily run through its full duration if it retained time from a previous cycle. The timer counts down from the inception of Absorption stage until it reaches zero. The time remaining can be viewed in the system display. 

The Absorption timer does not reset to its maximum amount, or to zero, when AC power is disconnected or reconnected. It only goes to zero if the timer runs out during Absorption stage, or if an external **STOP BULK** command is sent. In other cases it retains any remaining time.

Absorb Time is reset to its maximum amount whenever the battery voltage decreases to the **Re-Bulk Voltage**. The reset occurs immediately, regardless of the time spent below this point.

To skip this step: Setting **Absorb Time** to a very short duration causes the charger to spend minimal time in Absorption once the Bulk stage is complete. Setting **Absorb Time** to zero will cause the charger to skip both the Bulk and Absorption stages and proceed directly to the constant-current Float stage. This may not be desired if the intent is to skip Absorption but retain the Bulk stage.

Silent

This is not a charging stage, but a quiescent period between stages. The inverter remains on the AC source, but the charger is inactive. It enters this condition upon completing a timed stage such as Absorption, Float, or Equalize.

In Silent, the batteries are not in significant use by the inverter, but they are also not being charged. The battery voltage will naturally decrease when not maintained by another means such as a renewable source.

The term “Silent” is also used in an unrelated context regarding **Power Save**. See the **Power Save** section of the *Installation Manual*.

Voltage Used: **Re-Float Voltage** setting. When the battery voltage decreases to this point, the charger becomes active again. The default set point is 50.0 Vdc.

To skip this step: Setting **Float Time** to **24/7** makes the charger remain in Float continuously so that it does not proceed through the Silent, Bulk, Absorption, or Float timer steps.

Float Stage

This is the third stage of charging. It is sometimes known as maintenance charging. Float stage balances the batteries' tendency to self-discharge (as well as balancing the draw of any other DC loads). It maintains the batteries at 100% of capacity.

Voltage Used: **Float Voltage** setting. The default set point is 54.4 Vdc. This setting is also used by **Offset** when in this stage. (See page 36.) For the charger to work normally, this setting needs to be higher than the **Re-Float Voltage** setting.

The charger may perform two functions during Float. Both are called **Float** in the system display. They are defined here as **Refloat** and **Float**.

Refloat

Refloat is a constant-current function. The initial DC current may be as high as the charger's maximum current, depending on conditions. This stage is similar to Bulk, except that the charger uses the **Float Voltage** setting as noted above. The charger delivers current until the batteries reach this value.

Float

Float is a constant-voltage function. The charging current varies as needed to maintain **Float Voltage**, but typically drops to a low number. This stage is similar to Absorption, except that the voltage is different.

Time limit: *Float Time* setting. The charger will go Silent once the timer has expired (if another stage is not still in progress.) The Float timer is reset to its maximum amount whenever the batteries decrease to the *Re-Float Voltage* setting.

NOTE: The Float timer begins running any time the battery voltage exceeds the *Float Voltage* set point. This usually means that it begins running during the Bulk stage, once the battery voltage rises above that level. Often the timer will expire before the bulk and absorption stages are complete. (This will occur if the *Float Time* setting is less than the total of the bulk and absorption stages.) The charger will not enter Refloat or Float but will go directly to Silent. The charger only spends time in Float stage if the timer is still running.

To skip this step: Decreasing the *Float Time* setting to zero causes the inverter to enter Silent as soon as the absorption stage is complete. The inverter will perform neither the constant-current Refloat nor the constant-voltage Float.

Setting *Float Voltage* equal to the *Absorb Voltage* level causes the charger to proceed through the normal three-stage cycle, but at a single voltage.

NOTE: Setting *Float Time* to **24/7** causes the charger remain in Float continuously so that the Float timer no longer applies. (The charger also skips Bulk, Absorption, and Silent.) However, the charger can begin a single three-stage charge if the criteria are met, after which it will return to continuous Float.

Silent

Following the expiration of the Float timer, the unit enters (or re-enters) the Silent stage. The unit remains connected to the AC source, but the charger is inactive.

The unit will continue cycling between Float and Silent for as long as the AC source is present.

New Charging Cycle

If the AC source is lost or disconnected, the unit will return to inverting mode if enabled. The battery voltage will begin to decrease due to loads or natural loss. When the AC source is restored, the inverter will return to the charging cycle.

Re-Bulk

If the battery voltage decreases due to discharge, the inverter will restart the cycle as soon as the AC source is available, beginning at Bulk stage.

Voltage Used: *Re-Bulk Voltage* setting. The default set point is 49.6 Vdc.

If the batteries do not decrease to the Re-Bulk point, the charger will not enter the Bulk stage and will return to its previous stage.

Absorption Timer

Time limit: *Absorb Time* setting. This is reset to its maximum amount whenever the battery voltage decreases to the *Re-Bulk Voltage* setting. The reset occurs immediately, regardless of the duration spent below this voltage.

If the battery voltage does not decrease to the Re-Bulk point, the *Absorb Time* setting will not reset. It will retain any remaining time from the previous cycle. The Absorption stage will only last for the duration of the remaining time.

The remaining charging steps proceed as described on the previous pages.

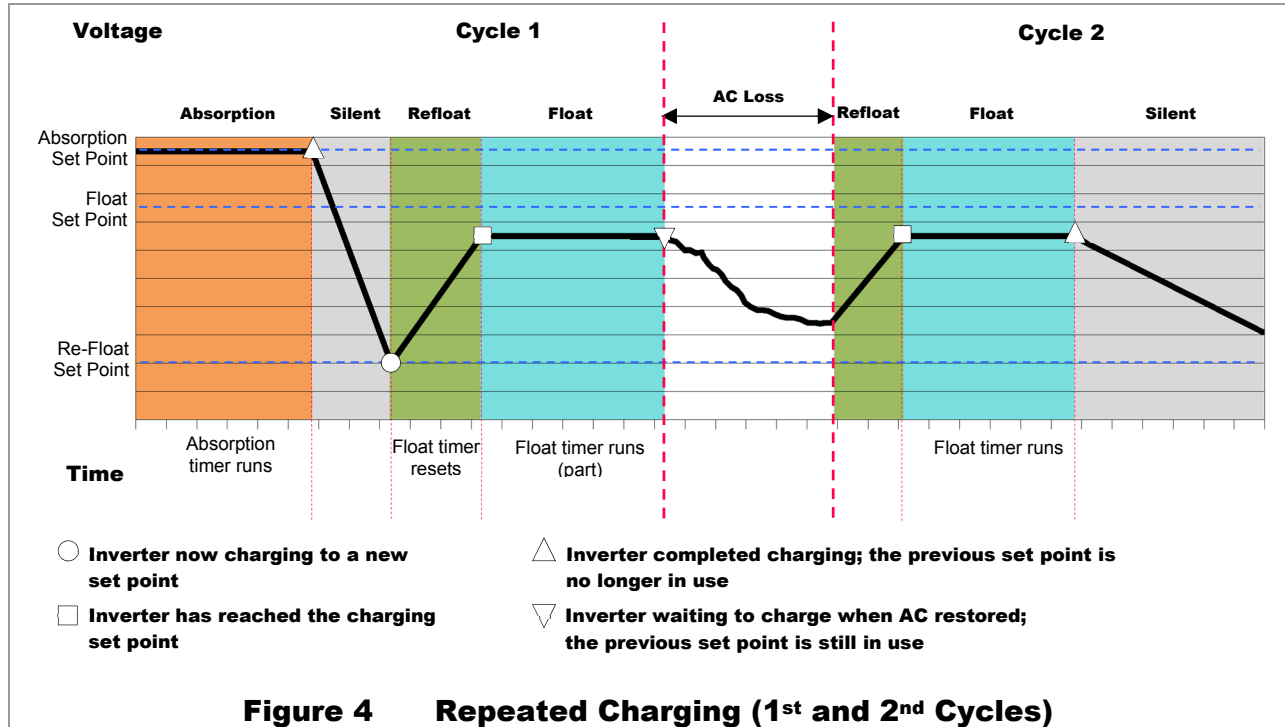

Example of Multiple Cycles

- In Figure 4 (Cycle 1), the charger initially completes Absorption. When the Absorption timer expires, the charger goes Silent until battery voltage decreases to the **Re-Float** setting. The Float timer is reset to its maximum. The charger proceeds through Re-Float and Float until it is interrupted by a loss of AC power.
- Cycle 2 begins when the AC source is restored. During the AC loss, the battery voltage did not decrease to the **Re-Float** setting, so **Float Time** retains the remainder of the previous cycle. The charger returns to Re-Float and proceeds through the Float stage. Cycle 2 completes the Float stage when its timer expires. It then goes Silent.

Note that in Cycle 1, **Absorb Time** had expired. It was not reset afterward and retained a “remaining run time” of zero. The Bulk and Absorb stages do not occur on subsequent cycles until the timer reads something other than zero.

- This graph is continued in Figure 5. During the Silent period AC is lost again. The battery voltage decreases until it reaches the Re-Bulk set point. This causes the charger to prepare a new three-stage cycle from the beginning, but it cannot do so until the AC source is restored.

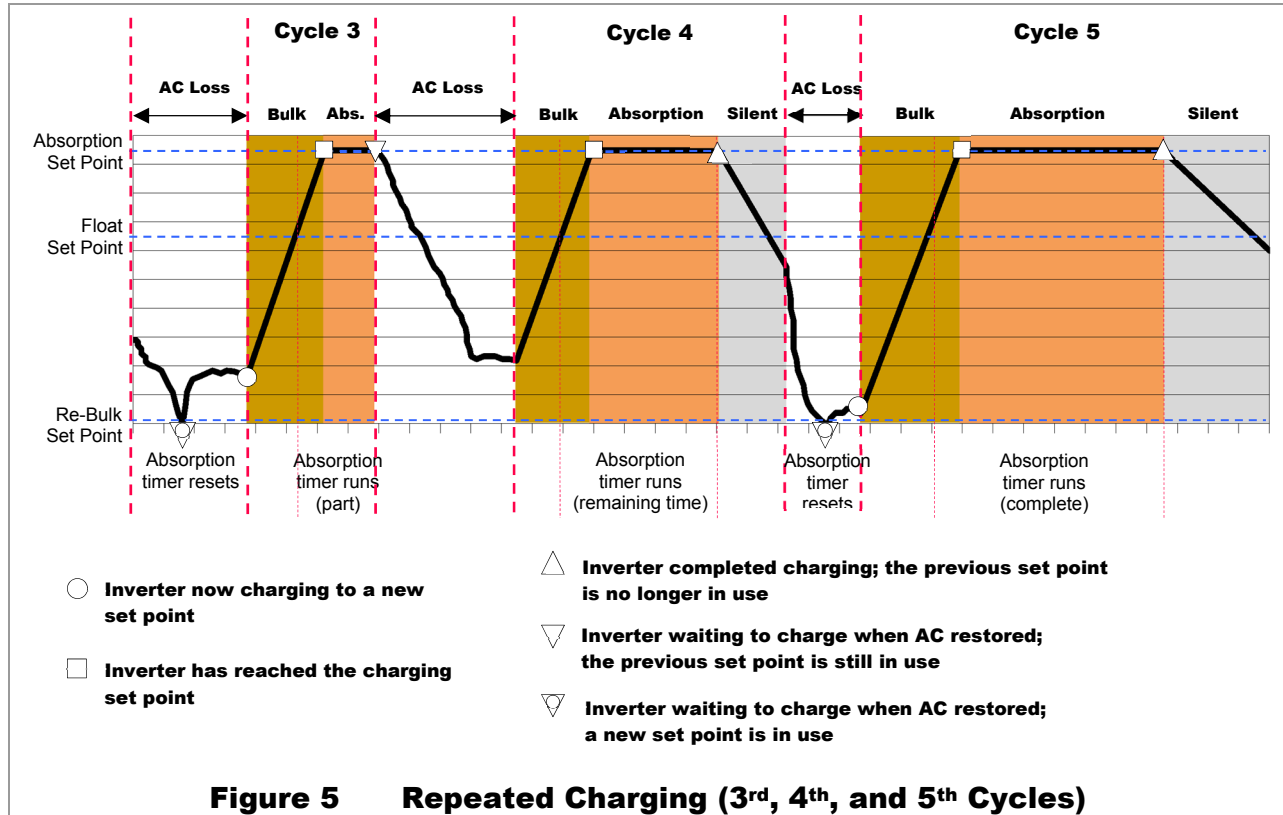

- Prior to the beginning of Cycle 3, the AC source was lost. The battery voltage decreased below the level of the **Re-Bulk** set point. Whenever this occurs, the Absorption timer resets to its maximum amount.
- In Figure 5, Cycle 3 begins when the AC source is restored again. The charger begins a new cycle by entering Bulk stage. When it enters Absorption, the timer runs until it is interrupted by a loss of AC power.
- Following Cycle 3, the voltage does not decrease below **Re-Bulk**. The Absorption timer retains the remaining time from Cycle 3.
- Cycle 4 begins when the AC source is restored again. The charger enters Bulk stage and proceeds to Absorption. This stage does not last for the full duration of the **Absorb Time** setting. The timer uses up the remaining time from Cycle 3. Absorption ends when the timer expires.

In this example, the duration was also longer than the **Float Time** setting. Because the Float timer began running near the beginning of Cycle 3 and also Cycle 4 (when the batteries exceeded the **Float Voltage** setting), the **Float Time** has also expired. The charger does not enter Refloat or Float and goes Silent.

During the Silent period, AC is lost again. The battery voltage decreases until it reaches the **Re-Bulk** set point, prompting a new charge cycle. The Absorption timer resets to its maximum amount.

- When Cycle 5 begins, the charger proceeds through the Bulk stage and then the Absorption stage. At the end of Cycle 5, the **Float Time** has expired, so the charger goes Silent.

Equalization

Equalization is a controlled overcharge that is part of regular battery maintenance. Equalization brings the batteries to a much higher voltage than usual and maintains this high voltage for a period of time. This has the result of removing inert lead sulfate compounds from the battery plates. It also reduces stratification by circulating the electrolyte.

Equalization follows the same pattern as standard three-stage charging, as shown in the figures on page 28. However, instead of the Absorption voltage and time set points, it is controlled by the **Equalize Voltage** and **Equalize Time** settings in the system display.

The Radian inverter can perform **Offset** when equalizing. (See page 36.) **Equalize Voltage** is also the reference voltage for **Offset** during equalization.

This process must be started manually using the system display. The inverter cannot be programmed for automatic battery equalization. This is a safety measure.

- Equalization is normally performed only on flooded lead-acid batteries. The schedule for equalization varies with battery use and type, but it is usually performed every few months. If performed correctly, this process can extend battery life by a considerable amount.
- Equalization is not normally performed on nickel-technology batteries. It is not normally performed on any sort of sealed battery.



CAUTION: Battery Damage

- ❖ Do not equalize any sealed battery types (VRLA, AGM, Gel, or other) unless approved by the manufacturer. Some batteries may suffer severe damage from equalization.
- ❖ Contact the battery manufacturer for recommendations on equalization voltage, duration, schedule, and/or advisability. Other battery manufacturers may use a different definition of equalization than that shown above. Always follow manufacturer recommendations for equalization

Battery Temperature Compensation

Battery performance will change when the temperature varies above or below room temperature (77°F or 25°C). Temperature compensation is a process that adjusts battery charging to correct for these changes.

The Radian inverter, when equipped with the Remote Temperature Sensor (RTS), will compensate for changes in temperature. To achieve a representative temperature, the RTS is attached to a single battery near the center of the bank. The Radian inverter has a designated port for RTS installation. 

If temperature compensation is not used:

When a battery is cooler than room temperature, its internal resistance goes up and the voltage changes more quickly. This makes it easier for the charger to reach its voltage set points. However, while accomplishing this process, it will not deliver all the current that the battery requires. As a result, the battery will tend to be undercharged.

Conversely, when a battery is warmer than room temperature, its internal resistance goes down and the voltage changes more slowly. This makes it harder for the charger to reach its voltage set points. It will continue to deliver energy as time passes until the charging set points are reached. However, this tends to be far more than the battery requires. The battery will be overcharged and is likely to have a shorter life.

If installed in a system networked with a HUB Communications Manager, only a single RTS is necessary. In most cases the RTS must be plugged into the master inverter. A system display must be present for the compensation values to be shared to all devices.

NOTE: In the FLEXmax 100 or FLEXmax Extreme charge controller, the rate of compensation is adjustable. (See **Slope** below.) When changing the compensation rate in one of these products, the RTS should be plugged into that controller, not the master inverter, to share the new value with other devices. The communications manager and system display must still be present to share the values.



IMPORTANT:

- ❖ If the RTS is connected to an OutBack device other than those listed above, the compensation values will not be shared.
- ❖ If a system display is not connected, the compensation values will not be shared.
- ❖ If the RTS is not connected to one of the charge controllers designated above, the controller's compensation values will not be shared.
- ❖ See the applications note at www.outbackpower.com for more information on this topic.

When charging, an inverter system with an RTS will adjust the charging voltage inversely with changes in temperature. It will **increase** the charge voltage by 5 mV for every decrease of 1 degree Celsius per battery cell. Similarly, it will **decrease** the voltage 5 mV for every increase of 1°C per cell.

This setting affects the **Absorption**, **Float**, and **Equalization** set points. The **Sell Voltage** and **Re-Float Voltage** set points are not temperature compensated. The **Equalization** set points are not compensated in OutBack charge controllers.

- In a 48 Vdc system (24 cells, 2 volts each), this means 0.12 volts per degree Celsius above or below 25°C. Maximum compensation is ± 2.4 Vdc.

EXAMPLES:

- A 48 Vdc system with batteries at 15°C will compensate its charging to 1.2 Vdc **higher** than the set points.
- A 48 Vdc system with batteries at 40°C will compensate its charging to 1.8 Vdc **lower** than the set points.

Slope

Some batteries require different amounts of compensation. The OutBack FLEXmax 100 and FLEXmax Extreme charge controllers have an adjustable rate of compensation (“slope”) and are not limited to 5 mV. The HUB Communications Manager can network these controllers with the inverter. If this is done, the inverter can import the slope setting from the controller. 



NOTE:

Temperature compensation only applies to the battery charging function. Other set points in the inverter, such as the **Aux** functions, are not compensated for temperature.

Offset

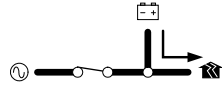

Offset is an automatic operation which occurs in certain conditions. It is not a programmable inverter function.

This operation uses excess battery energy to power the loads when an AC source is present. The system can take advantage of renewable energy sources, “offsetting” dependence on the AC source.

The battery voltage increases as a renewable energy source charges the batteries. When the battery voltage exceeds a designated reference voltage, the Radian inverter begins inverting. It draws power from the batteries (discharging them) and uses that power to offset the use of the AC source.

The Radian inverter uses excess DC energy for this function under the following rules:

- If the load demand is higher than the exported power, the inverter’s use of the AC source is reduced. The exported amount of power has “offset” the same amount of demand on the AC source. (This is sometimes known as “selling to the loads”.)
- If the excess DC energy (and exported power) is equal or greater than the load demand, and the Radian is in the **Grid Tied** input mode, the inverter will sell the additional power to the utility grid. This is the key priority of the **Grid Tied** mode.

The Radian inverter uses several set points as reference voltages for the offsetting operation, particularly the battery charger settings.

- The charger settings **Absorb Voltage**, **Float Voltage**, and **Equalize Voltage** (as shown in the system display) are all used as reference voltages. Normally the charger regulates to these set points by adding power to the batteries. Offsetting does the opposite; it uses the same set points but regulates the voltage by *removing* power from the DC side of the system.
- If none of the battery charger’s timers are active, the reference voltage is **Sell Voltage** in the **Grid-Tie Sell** menu. This is true in any input mode where **Offset** is used, not just the **Grid Tied** input mode.
- The **GridZero** mode only uses a single reference voltage for **Offset**, the **DoD Volts** setting.

NOTES:

- The **Offset Enable** menu item must be set to **Y** (yes) for **Offset** to work.
- Offsetting operation is available in the **Support**, **Grid Tied**, and **GridZero** modes.
- Offsetting operation is available in the **Mini Grid** mode. However, it may not be used often since the **Mini Grid** priority is to avoid grid use.
- Offsetting operation is not available in the **Generator**, **UPS**, and **Backup** input modes.

Table 3 Offset Interaction with AC Source

Mode	Excess DC ≥ loads	Excess DC < loads
Generator	Does not function	
Support	Offsets load use, but also uses DC to support the AC source based on Support mode settings	
Grid Tied	Sells excess to AC source (grid); remains connected	Offsets loads with whatever power is available
UPS	Does not function	
Backup	Does not function	
Mini Grid	Offsets loads with whatever power is available; inapplicable if disconnected from utility grid	
GridZero	Offsets load use, but only according to the DoD Volts setting	

Grid Support

The Radian meets the definition of a “Grid Support Utility-Interactive Inverter/Converter” as described by UL 1741 SA. Grid support functionality makes use of the inverter’s capabilities to prevent destabilization of the utility grid.

Grid Support functionality is only available in the **Grid Tied** and **GridZero** input modes. When either mode is selected, the settings within the **Grid Support** menus are active. The default settings support only the standard voltage and frequency magnitude and trip limits specified by IEEE 1547. All other advanced grid support functions are disabled. If local jurisdiction requires grid support functionality, some or all of the advanced functions may be required.

The standards set by different utility companies or local jurisdictions require different parameters and settings. The general parameters used by **Grid Support** are displayed under the following screen selections. Installing a .GIP file (as instructed by the *Installation Manual*) will automatically load a package of **Grid Support** settings.

- **Regulatory Specification** — the code or utility company regulation which indicates the following settings (preloaded by the .GIP file).
- **Low/High Voltage Ride-Through²** — the high or low limit for AC voltage disturbances. If these limits are exceeded for the **Trip** time or longer, the inverter will disconnect from the utility grid. For a lesser duration the inverter is required to “ride through” the disturbance and remain connected.
- **Low/High Frequency Ride-Through²** — the high or low limit for AC frequency disturbances. If these limits are exceeded for the **Trip** time or longer, the inverter will disconnect from the utility grid. For a lesser duration the inverter is required to “ride through” the disturbance and remain connected.
- **Fixed Power Factor** — the power factor to be produced by the inverter when offsetting or selling.
- **Ramping** — the rate of power increase when first ramping (**Start Ramp**) and subsequent increases in offsetting or selling (**Normal Ramp**).
- **Frequency Watt** — consists of two functions.
 - ~ When the AC input frequency increases above the nominal value, the inverter will reduce offsetting.
 - ~ When the AC input frequency decreases below the nominal value, the inverter will increase offsetting or reduce charging.
- **Volt Watt** — consists of two functions.
 - ~ When the AC input voltage increases above the nominal value, the inverter will reduce offsetting.
 - ~ When the AC input voltage decreases below the nominal value, the inverter will increase offsetting or reduce charging.
- **Volt/VAr** — consists of two functions.
 - ~ When the AC input voltage decreases below the nominal value, the inverter will produce reactive power.
 - ~ When the AC input voltage increases above the nominal value, the inverter will consume reactive power.
- **Reconnect Parameters** — the AC voltage and frequency limits which must be met before the inverter can connect (or reconnect) to the utility grid.
- **Multi-Function Parameters**
 - ~ **% of Sell Current Limit** — for use in future revisions of firmware.
 - ~ **% of Charge Current Limit** — for use in future revisions of firmware.

² The settings required by IEEE 1547 for voltage and frequency magnitude and their trip limits are the default settings for these menu items.

Operation

The settings for each item will vary depending on the standards being applied. Not all functions are enabled. When a particular standard is applied, the settings will be pre-loaded accordingly.

The screen in Figure 6 shows which functions are enabled.

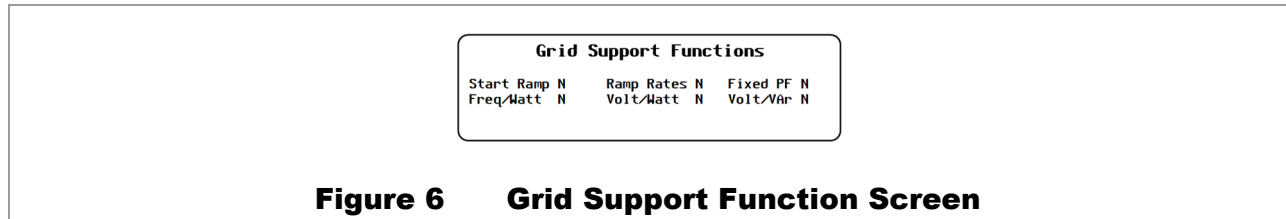

When **Grid Support** functions require the inverter to export power to help sustain grid voltage or frequency, the inverter will do so with respect to the following limits:

- An inverter in **Grid Tied** mode will observe the **Sell Current** limit and the **Sell Voltage** limit.
- An inverter in **GridZero** mode will observe the **DoD Amps** and the **DoD Volts** limits.

Auxiliary Terminals

The Radian inverter has two sets of terminals that respond to different criteria to control certain operations. The **12V AUX** terminals provide a 12 Vdc output that can deliver up to 0.7 Adc to control external loads. The **RELAY AUX** terminals are “dry” relay contacts rated up to 10 amps (at 250 Vac or 30 Vdc). Each set of terminals has its own set of programmed criteria. Each has identical options available. (When the options described below refer generically to the “**AUX** output”, it can mean either set of terminals.)

Each **AUX** output has three states: continuous **Off**, continuous **On**, and **Auto**, which allows that output to be activated using the automatic auxiliary functions. (All functions are defaulted to **Auto**.) These items are based in the Radian inverter and accessed using the system display. The system display and other devices have separate programming, such as Advanced Generator Start (AGS), that can also control the **AUX** outputs. To avoid conflicts, the output should be **Off** when the AGS function is active.

For the Radian automatic functions, typical applications include signaling a generator to start, sending a fault alarm signal, or running a small fan to ventilate the batteries. When considering these applications, plan for both connection requirements and programming with the system display. 

The **AUX** terminals have a series of set points which are used by various functions. Both sets of terminals have the same options available, but they are programmed independently. Not all set points are used by all functions. Each **AUX** mode description below will detail the set points that are used for that function.

- ~ Low DC voltage settings
- ~ High DC voltage settings
- ~ On delay settings, in increments of 0.1 minutes
- ~ Off delay settings, in increments of 0.1 minutes

These are not temperature-compensated. Compensation is only used for inverter battery charging.

There are nine functions, each geared toward a different application. (The **12V AUX** and **RELAY AUX** outputs are defaulted to different selections.) These functions are summarized in Table 4 on page 42.

- **Load Shed** can perform load management. It is intended to turn off designated loads during low battery periods to conserve remaining battery power.
 - ~ When battery voltage rises above a settable high voltage level, the **AUX** output is activated after a settable delay. The **AUX** output is used to energize a larger external relay (normally open) which is connected to non-vital loads. The **AUX** output will be deactivated once the battery voltage falls below a low voltage setting for a settable delay period.
 - ~ Load Shed will also turn off when the inverter enters a high-temperature condition or when the AC output voltage drops below a specific AC voltage for more than 3 seconds. This voltage limit is 30 volts below the setting of the inverter’s output voltage. For the Radian inverter’s default output voltage of 240 Vac, the limit is 210 Vac, or 105 Vac if output L1 or L2 decrease in voltage independently. (See page 66.) The limit is not otherwise settable.
 - ~ **Load Shed** will also turn off if the input current exceeds the **Input AC Limit** setting while the inverter is using an AC source.
 - ~ Settable parameters include:
 - Low and high DC voltage
 - On and off delay

Operation

- **Gen Alert** is used as a controller for an AC generator with a remote start feature, although it has limited functionality. (The generator recharges batteries using the inverter's battery charger.)
 - ~ Either set of **AUX** terminals may be used to start the generator by closing the appropriate circuit. The specific choice of **RELAY AUX** or **12V AUX** may depend on the generator's starting circuitry. Different examples are illustrated in the *Radian Series Inverter/Charger Installation Manual*.
 - ~ The **AUX** output will activate to start the generator when the battery voltage falls to a low set point for a settable delay. The **AUX** output is deactivated, shutting off the generator, once the battery voltage rises to a high voltage setting for a settable delay period.
 - ~ Settable parameters include:
 - Low and high DC voltage
 - On and off delay
 - ~ Gen Alert control logic is located in the inverter. It has the advantage of functioning when the system display is removed. However, it may not completely charge the batteries and does not have all the advantages of the Advanced Generator Start (**AGS**) function that is found in the system display. For many users, the **AGS** function may prove more useful than **Gen Alert**. **Gen Alert**, however, could be used as a literal "Generator Alert", a signal to the user to manually start a generator.

NOTE: **Gen Alert** is the default selection for the **RELAY AUX** settings.



IMPORTANT:

When using **Gen Alert** (or AGS), the generator must be connected to the inverter's **GEN** terminals. If the input priority is set to **GRID** and the **GRID** terminals are energized, an automatically controlled generator will shut down. This prevents an automatic generator from working correctly when using the **GRID** terminals.

- **Fault** activates the **AUX** output when the inverter shuts down due to an error condition (see page 51). It can activate a light or alarm to show that the inverter has failed. With the appropriate devices, it could send an alarm signal through a radio, pager, or telephone dialer.
 - ~ This function does not have settable parameters.
 - **Vent Fan** activates the **AUX** output in response to a high DC (battery) voltage set point. It can run a small fan to ventilate the battery compartment to eliminate gases that result from battery charging. (This is illustrated in the *Radian Series Inverter/Charger Installation Manual*.) When the voltage falls below this set point for a settable delay period, the **AUX** output turns off.
 - ~ Settable parameters include:
 - High DC voltage
 - Off delay
- NOTE:** **Vent Fan** is the default selection for the **12V AUX** settings.
- **Cool Fan** activates the **AUX** output when the inverter reaches a high internal temperature. It is intended to trigger a small external fan for additional cooling. See the **Warning Troubleshooting** table on page 52 for a description of the fan criteria.
 - ~ This function does not have settable parameters.
 - **DC Divert** activates the **AUX** output to divert (or "dump") excess renewable energy to a DC load, such as a resistor, a heater, or a fuel cell. This prevents overcharging of the batteries. This function can serve as rough charge regulation for an external charging source.
 - ~ When battery voltage rises above a settable high voltage level, the **AUX** output is activated after a settable delay. The **AUX** output controls a larger, external relay. When energized, the relay

allows current to flow from the batteries to a dedicated DC load. (This is illustrated in the *Radian Series Inverter/Charger Installation Manual*.) The resistor or load must be sized to dissipate all of the energy from the renewable source if necessary. Diversion will turn off following a delay when a low DC voltage setting is reached.

- ~ Settable parameters include:
 - Low and high DC voltage
 - On and off delay
- **GT Limits** activates the **AUX** output as an alert that the utility grid does not meet Grid Interface Protection parameters for the grid-interactive function (see page 14). It can activate a light or alarm to show that the grid-interactive function has shut down and that there may be problems with the grid. The **AUX** output will cycle on and off if grid parameters are met and the reconnection timer is counting down.
 - ~ This function does not have settable parameters other than those of the **Grid Interface Protection** menu (see Table 17 beginning on page 63).
- **Source Status** activates the **AUX** output whenever the inverter accepts an AC source. It can activate a light or alarm to show that the utility grid is present or that a generator has started. Alternately, it could be used to show that the source has disconnected.
 - ~ This function does not have settable parameters.
- **AC Divert** activates the **AUX** output to divert (or “dump”) excess renewable energy to an AC load, usually an AC device powered by the inverter itself. This prevents overcharging of the batteries. This function can serve as rough charge regulation for an external charging source.
 - ~ When battery voltage rises above a settable high voltage level, the **AUX** output is activated after a settable delay. The **AUX** output controls a larger relay, which allows current to flow from the batteries to a dedicated AC load when energized. Diversion is usually used to regulate battery charging. The AC device is usually wired to the output or load panel and must be left on. It must be sized to dissipate all of the energy from the renewable source if necessary. Diversion will turn off following a delay when a low DC voltage setting is reached.
 - ~ The **AUX** output will automatically turn on to run the loads if the inverter accepts an AC source.
 - ~ Settable parameters include:
 - Low and high DC voltage
 - On and off delay
 - ~ During variable conditions, the **AUX** output is triggered no more than once per minute (if voltage conditions are still met). This prevents rapid nuisance cycling of the AC load.
 - ~ **AC Divert** should not be used as the sole source of battery regulation. If the inverter shuts down or fails, the batteries could suffer severe damage. This function should be supported by an external regulator.
 - If the inverter shuts down due to overload, the **AUX** output will also shut down. If the inverter load exceeds 30 Aac, the **AUX** output will turn off to prevent an overload condition.
 - If either the FETs or the capacitors (see page 52) become too hot, the **AUX** will turn off due to diminished inverter wattage capacity.

Note that even if every function in the menu is set to **Off**, external programming from other devices may still activate the **AUX** output. An example is the system display’s AGS function.

The **AUX** functions are summarized in Table 4.

Table 4 AUX Mode Functions

Name	Purpose	Triggers		Settable Points
		Start	Stop	
Load Shed	Operates designated loads normally; turns off loads in severe conditions	<ul style="list-style-type: none"> High Vdc 	<ul style="list-style-type: none"> Low Vdc High temp Low output Vac High input Aac 	<ul style="list-style-type: none"> Low & high Vdc On & Off delay
Gen Alert	Starts generator to charge batteries	<ul style="list-style-type: none"> Low Vdc 	<ul style="list-style-type: none"> High Vdc 	<ul style="list-style-type: none"> Low & high Vdc On & Off delay
Fault	Signals that the Radian shut down due to error	<ul style="list-style-type: none"> Error present 	<ul style="list-style-type: none"> Error cleared 	None
Vent Fan	Runs fan to vent batteries while charging	<ul style="list-style-type: none"> High Vdc 	<ul style="list-style-type: none"> Below high Vdc 	<ul style="list-style-type: none"> High Vdc Off delay
Cool Fan	Runs fan to cool Radian	<ul style="list-style-type: none"> Internal sensor > 60°C 	<ul style="list-style-type: none"> Internal sensor < 49°C 	None
DC Divert	Turns on DC dump load to prevent overcharging	<ul style="list-style-type: none"> High Vdc 	<ul style="list-style-type: none"> Low Vdc 	<ul style="list-style-type: none"> Low & high Vdc On & Off delay
GT Limits	Signals disconnect of grid-tied Radian due to AC conditions	<ul style="list-style-type: none"> GIP parameters not met 	<ul style="list-style-type: none"> GIP parameters met 	None
Source Status	Signals that the Radian accepted an AC source	<ul style="list-style-type: none"> AC source accepted 	<ul style="list-style-type: none"> AC source disconnected 	None
AC Divert	Turns on AC dump load to prevent overcharging	<ul style="list-style-type: none"> High Vdc AC source accepted 	<ul style="list-style-type: none"> Low Vdc High output load High temperature 	<ul style="list-style-type: none"> Low & high Vdc On & Off delay



Metering

MATE3-Class System Display Screens

A MATE3-class system display can monitor the inverter and other networked devices. From the Home screen, the **<Inverter>** “soft” key accesses the inverter monitoring screens. 

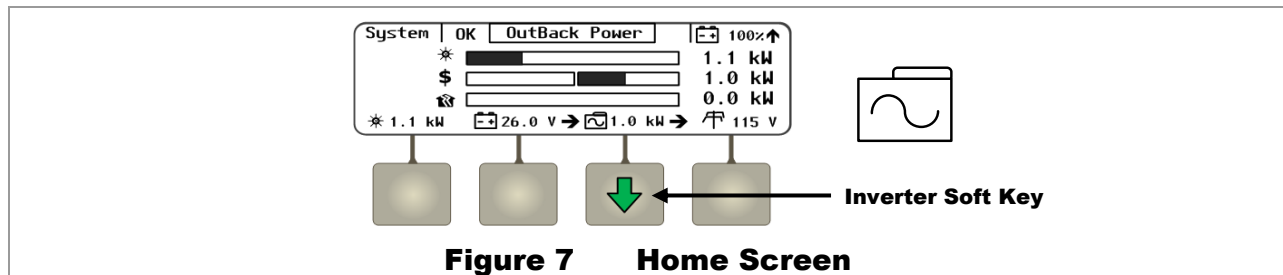

Inverter Screens

The Inverter soft key opens a series of screens showing the inverter operating mode, battery voltage, and status of several AC operations. The first screen displays AC information on the inverter’s L1 input and output. The **<Next>** soft key proceeds to a screen that shows the same information for L2. The **<Port>** soft key will select other networked inverters, if present.

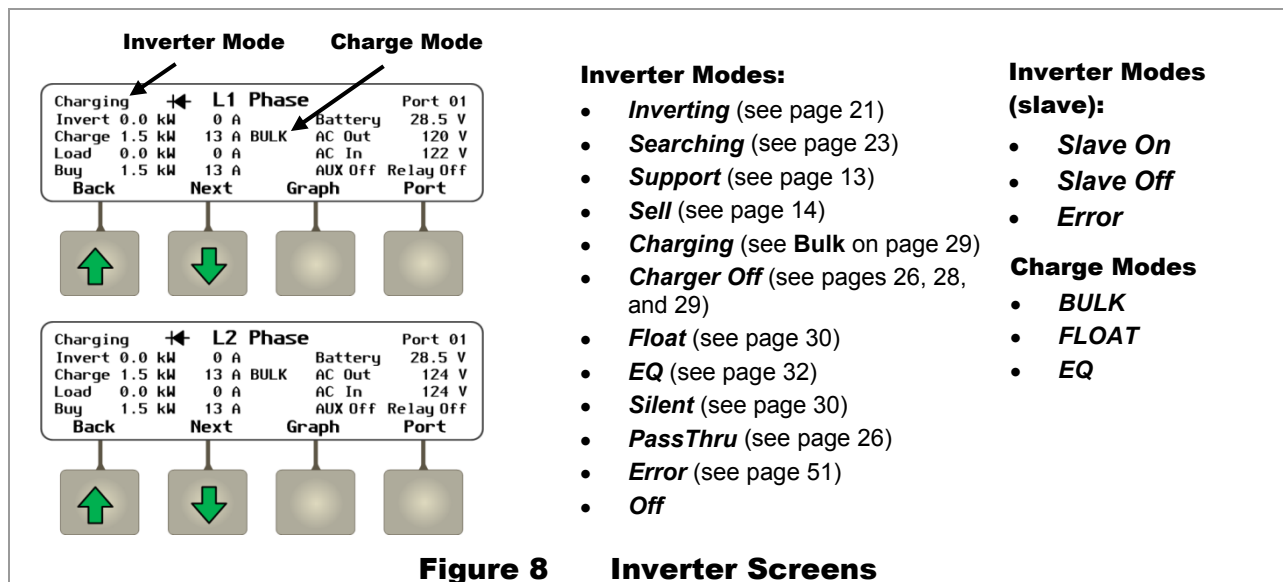

Screen items:

- The upper left corner is the **Inverter Mode** (see above). (If the selected inverter is a slave, only a few modes are possible.) When **Charging** is indicated in this location, the **Charge Mode** (see above) specifies the stage.
- **Invert** displays the kilowatts and AC amperage generated by the inverter. It may go to loads, or in a grid-interactive system it may be sold back to the utility grid.

Metering

- **Charge** displays the kilowatts and AC amperage consumed for the inverter to charge the battery bank. This line also shows the present charging stage.
- **Load** displays kilowatts and AC amperage consumed by devices on the inverter's output. It can be the same as **Invert**.
- **Buy** displays the kilowatts and AC amperage brought into the inverter's input for both charging and loads. This is usually a total of **Charge** and **Load**.
- **Battery** displays the uncompensated battery voltage.
- **AC Out** displays the AC voltage measured at the inverter's output (the sum of the L1 and L2 readings). If an AC source is present, this reading is usually the same as **AC In**.
- **AC In** displays the AC voltage measured at the inverter's input from an AC source (the sum of the L1 and L2 readings). This number may be erratic or inaccurate upon first connection until the inverter synchronizes with the input source.
- **AUX** displays the current status of the inverter's Auxiliary (**AUX**) 12-volt output. **Relay** displays the current status of the inverter's **AUX** relay contacts. (See page 39.)
- A diode symbol may appear to the left of the screen name to indicate "diode charging" mode. This is a mode that allows fine control of charging, selling, and load support. It does not visibly affect operation.

From either **L1 Phase** or **L2 Phase**, the **<Graph>** soft key brings up a series of screens which plot various types of data over time on the system display screen. 

Battery Screen

From the **L2 Phase** screen, the **<Next>** soft key brings up a screen showing charger status, charger settings, and battery voltage and temperature information.

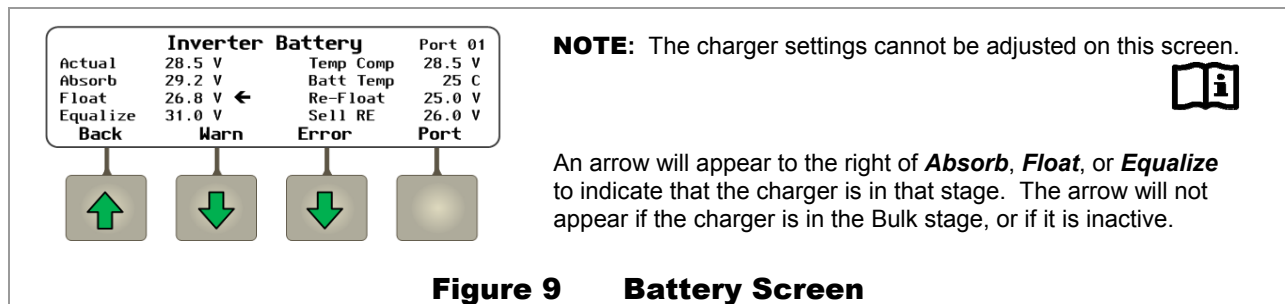

Figure 9 Battery Screen

Screen items:

- **Actual** displays the uncompensated battery voltage.
- **Absorb** displays the charger's Absorption voltage setting. (See page 29.)
- **Float** displays the charger's Float voltage setting. (See page 30.)
- **Equalize** displays the charger's Equalization voltage setting. (See page 32.)
- **Temp Comp** displays the corrected battery voltage using temperature readings from the RTS. If no RTS is present, **Temp Comp** and **Actual** will read the same. (See page 34.)
- **Batt Temp** displays the battery temperature in degrees Celsius, as measured by the RTS. It is only valid for port 1 on the HUB. If other ports are selected, or if no RTS is present, the characters **###** will be displayed.
- **Re-Float** displays the Re-Float setting which was programmed into the inverter's charger. This is the voltage used for the inverter to return from Silent mode to the float stage. (See page 30.)
- **Sell RE** voltage is the target voltage used by the inverter for the grid-interactive and other **Offset** functions when the charger is otherwise inactive. (See pages 14 and 36.)

The **<Warn>** and **<Error>** keys bring up various fault screens. See the next section.



Troubleshooting

Basic Troubleshooting

Table 5 is organized in order of common symptoms, with a series of possible causes. Each shows possible troubleshooting remedies, including system display checks where appropriate.

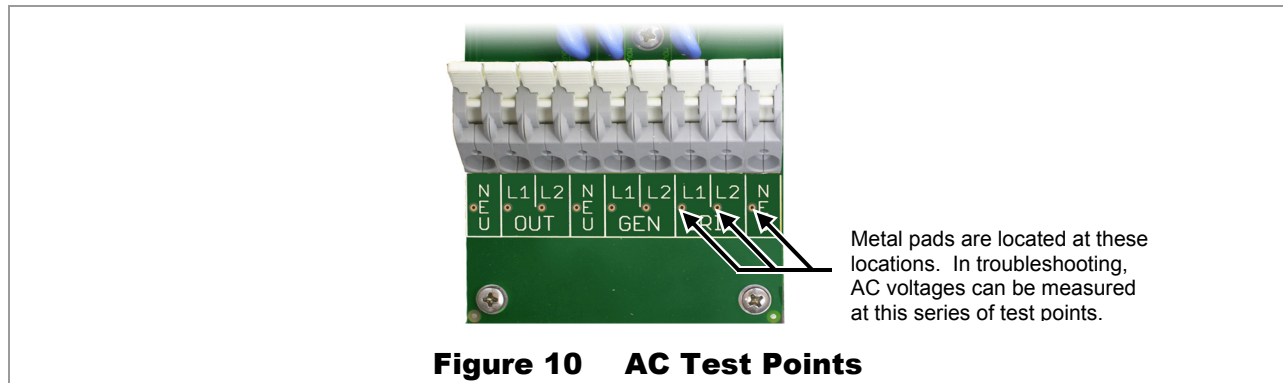

Figure 10 AC Test Points

	<p>WARNING: Shock Hazard</p> <p>During an error shutdown, the inverter's output terminals are not live. However, if the inverter recovers from a shutdown, the terminals will become live without notice. Several error shutdowns can be recovered automatically, including Low Battery V, High Battery V, and Over Temperature. See page 51.</p>
	<p>NOTE:</p> <p>In Table 5, "System display only" usually indicates that a MATE3-class device is required to perform the step. It cannot be performed without the system display.</p>

Table 5 Troubleshooting

Symptom	Possible Cause	Possible Remedy
No AC output (will not invert).	No DC voltage.	Use a DC voltmeter to check the voltage directly on the DC terminals. If not present, the problem is external. If present, the inverter could be damaged.
	Jumper J3 missing.	See the <i>Installation Manual</i> for the location of J3. Confirm the jumper is present. If missing, replace the jumper. Or follow the manual instructions to install an external switch.
	Unit defaulted off (No system display; initial install; J3 confirmed present).	The Radian inverter is given an initial Off command in the factory. With DC present, use narrow pliers to remove jumper J3 from its pins. Once removed, install it again. This is the equivalent of "jiggling the switch."
	Inverter set to Off .	<i>System display only:</i> Set to On with the INVERTER hot key. NOTE: The ON/OFF jumper must be installed.
	Inverter set to Search (Search mode).	<i>System display only:</i> If constant power is required, set to On with the INVERTER hot key. (If this setting was intentional, then no action is required.)

Table 5 Troubleshooting

Symptom	Possible Cause	Possible Remedy
One or more units have no output but others do (in multi-inverter system).	Unit is slave and is in Silent mode.	<i>System display only:</i> Check Power Save Levels in the Inverter Stacking menu and test with loads. Determine if the inverter comes on at the appropriate levels. (If this setting was intentional, then no action is required.)
Will not connect to the AC source.	No AC input.	Check the AC voltage on the inverter's input test points. (See page 45.) If not present, the problem is external. If present, the inverter could be damaged.
	The L1 output is wired to its L2 input, or the other way around. The problem is accompanied by shifts in frequency.	Disconnect the wires from the inverter's AC input terminals or AC output terminals, or both. If the problem immediately disappears, it is an external wiring issue. The inverter's input and output terminals must remain isolated from each other.
	AC source does not meet requirements.	<i>System display only:</i> Check the Last AC Disconnect screen (using the AC INPUT hot key and the Discon selection) for the reason for disconnection. If it never originally connected, check the Warning menu (using the <Inverter> soft key from the Home screen). Confirm source voltage / frequency.
	AC source meets requirements but is "noisy" or irregular.	<i>System display only:</i> The Generator input mode can accept irregular AC power. Select that mode for that input.
	Inverter was manually set to disconnect from AC.	<i>System display only:</i> Change the AC Input Control setting from Drop to Use with the AC INPUT hot key. (If this setting was intentional, then no action is required.)
	Grid use function has disconnected from AC.	<i>System display only:</i> If activated prematurely, check the Grid Use Time settings and the system display clock. (If this setting was intentional, then no action is required.)
	High Battery Transfer (HBX) mode has disconnected from AC.	<i>System display only:</i> Check the AC INPUT hot key screen to see if HBX mode is in use. If activated prematurely, check the settings of HBX mode. (If this setting was intentional, then no action is required.)
	Mini Grid input mode has disconnected from AC.	<i>System display only:</i> Check the Inverter part of the Settings menu to see if Mini Grid mode is in use. If activated prematurely, check the settings of Mini Grid mode. (If this setting was intentional, then no action is required.)
	Conflicting programming.	<i>System display only:</i> Check to see if more than one of these is enabled: Mini Grid , HBX , Grid Use Time , Load Grid Transfer . Due to conflicting priorities, only one can be used.
	Grid Tied mode has disconnected from AC.	AC source does not meet requirements; see related entry under "Will not sell power to the utility grid" (next page).
	Conflicting AC sources. Priority input is interfering with secondary input.	If AC is present on the priority input, the inverter will not connect to AC on the second input. This is true even if the first input is not connected for other reasons (programming, low power quality).
Will not charge.	No AC input.	See "Will not connect to AC" category.
	Charger set to Off .	<i>System display only:</i> Check the Charger Mode screen with the CHARGER hot key and set to On or Auto . (If this setting was intentional, then no action is required.)
	GridZero mode in use.	<i>System display only:</i> The charger is inoperative in GridZero . (If this setting was intentional, then no action is required.)

Table 5 Troubleshooting

Symptom	Possible Cause	Possible Remedy
Low charge rate.	Charge complete or nearly complete.	Check the DC voltage and charging stage using the system display, if present. Confirm with DC voltmeter.
	System display DC meter reads significantly higher than actual battery voltage.	Check the DC voltage on the inverter's DC terminals. If different from the system display reading, the inverter could be damaged. Otherwise, check the DC voltage on batteries with a voltmeter. If different from the reading on the inverter, this could be a DC connection problem.
	High output loads.	If total loads and charge exceed the AC input setting, charge rate decreases to give priority to the loads. Turn off some of the output loads and test the charge rate again.
	High temperature.	The inverter will reduce the current rate for charging and other activities if the internal temperature exceeds a certain level. Check temperature and allow the inverter to cool if necessary. (See page 53.) External cooling may also be applied.
Will not sell power to the utility grid.	Grid-tied function has been manually disabled.	<i>System display only:</i> Check the Grid-Tie Enable setting in the Grid-Tie Sell menu. Confirm it is set to Y .
	Grid Tied mode not in use on the appropriate input.	<i>System display only:</i> Check the Inverter part of the Settings menu to see if Grid Tied mode is in use. Confirm that it has been selected for the correct Radian input terminals.
	AC source does not meet requirements; this item is usually accompanied by disconnecting from the utility grid when in Grid Tied mode.	Verify grid voltage and frequency. Determine if they are within the inverter's approved limits. If not, the inverter is operating correctly. Contact the utility company if necessary. <i>System display only:</i> The program limits are found in the inverter's Grid Interface Protection menu. See page 14 for more information on this menu.
	The inverter has other criteria besides the AC source which must be met, such as the qualifying time.	<i>System display only:</i> Check Sell Status screen using the Home screen's soft keys. The inverter may be operating correctly. Depending on the conditions which need to be met, the delay may be temporary,
	The inverter will perform the Offset function before attempting to sell.	Output loads can consume all excess renewable power if they are large enough. (The Offset function "sells to the loads.") Turn off some output loads and observe the sell operation.
Reduced power sold to the utility grid.	AC source voltage is driven high when the inverter sells large amounts of power.	When the inverter senses a rise in grid voltage while selling, it reduces the sell current, to avoid forcing the voltage to unacceptable levels. Check AC input voltage while selling. The inverter may be operating correctly.
	High temperature.	The inverter will reduce the current rate for selling and other activities if the internal temperature exceeds a certain level. Check temperature and allow the inverter to cool if necessary. (See page 53.) External cooling may also be applied.
Inverter does not perform the Offset function when expected.	Incorrect input mode.	Offset does not function in Generator , UPS , and Backup modes. (If this setting was intentional, then no action is required.)
	Specific mode only offsets under particular conditions.	Support mode will perform the Support function based on load. This may appear as Offset without reaching the reference voltage. GridZero mode will perform Offset based on the DoD Volts setting. Other reference voltages are not used.

Table 5 Troubleshooting

Symptom	Possible Cause	Possible Remedy
Unusual voltage on hot or neutral output line.	System neutral and ground may not be bonded.	Test L1 OUT , L2 OUT , and N OUT test points with AC voltmeter. (See page 45.) These measurements should give full voltage. Test neutral and ground connections. This measurement should read zero volts. Any other result means neutral and ground are not bonded correctly. If this is the case, the hot line often reads 60 to 75 Vdc and the neutral reads 45 to 60 Vdc with respect to ground. (If bonding is not required or is prohibited by national or local codes, then no action may be required.)
Unusual and different voltages on AC hot input lines.	Input neutral is not connected correctly. The inverter also may not connect to the AC source. Loads may behave unusually.	Test L1 input and neutral connections with AC voltmeter. Test L2 input and neutral connections with AC voltmeter. (This can be on GRID or GEN input, depending on where the symptoms appear.) Test L1 to L2 input. From hot to neutral should be approximately 120 Vac unless the output has been adjusted. L1 to L2 should be approximately 240 Vac. If the two outputs are different voltages but still add up to 240 Vac, the neutral is not connected to the inverter.
	Inverter has not synchronized with input source.	<i>System display only:</i> The AC In reading accessed by the <Inverter> soft key may be erratic or inaccurate after initial connection until the inverter has synchronized with the AC source. This may require a short time.
Loads drop out or crash during transfer.	Erratic AC source voltage.	Check AC voltage on the inverter's input test points. (See page 45.) If not consistent, the problem is external. <i>System display only:</i> AC source voltage may have dipped or hovered at a low enough point to crash a sensitive load before the inverter could take over. This can happen if the inverter's Grid AC Input Voltage Limits or Gen AC Input Voltage Limits were turned down to accommodate a problematic AC source. To make the inverter respond sooner, raise the lower limit setting in the appropriate menu. (If this setting was intentional, then no action is required.)
	Inverter set to Search (Search mode).	The unit will take a moment to come out of Search mode after transferring. <i>System display only:</i> If constant power is required, set to ON with the INVERTER hot key. (If this setting was intentional, then no action is required.)
	Loads sensitive to inverter's transfer time. UPS mode not in use on the appropriate input.	<i>System display only:</i> Most of the input modes feature a small but noticeable response time during transfer. Certain loads (such as highly sensitive computers) may not respond well. The UPS mode has a faster response time. Select this mode for the appropriate input. (See page 16.)
	Loads too large.	The unit can transfer more power than it can invert. If loads are oversized, the unit will falter or crash when switching to batteries. Reduce the size of the loads.
	Undersized battery cables.	Battery cables smaller than recommended will cause a significant voltage drop when switching to batteries, acting like either an overload or a low-battery condition. Size all cables correctly.

Table 5 Troubleshooting

Symptom	Possible Cause	Possible Remedy
Unit reads AC input, even though no source is present.	Internal transfer relay may be damaged. May be accompanied by AC Relay Fault error and shutdown.	Disconnect AC input wires and turn inverter on. Test the AC input and neutral test points with an AC voltmeter. (See page 45.) If voltage appears there, the transfer relay may be jammed. This problem is not common. If this occurs, it is usually on only the GRID or GEN input — not both.
	False reading due to noise.	Electrical noise can cause false readings on the metering circuits when no voltage is present. The readings are usually less than 30 Vac. If this is the case, no action is required.
Inverter clicks repeatedly. AC output voltage rises or drops to unusual levels with every click.	Inverter's output has been connected to its input. Voltage shifts are the result of trying to match its own voltage.	Disconnect the wires from the inverter's AC input or AC output terminals, or both. If the problem immediately disappears, it is an external wiring issue. The inverter's AC IN and AC OUT must remain isolated from each other.
	Low AC input voltage. Can be caused by weak AC source, or by faulty input connection.	Test AC hot and neutral input test points with an AC voltmeter. (See page 45.) If low or fluctuating, this is an external problem.
	A generator is connected to the input terminals while the unit is in the Grid Tied input mode.	The inverter is not intended to sell power to a generator. The selling activity will drive the generator voltage up to the disconnection point. It will then reconnect to the generator and try again. Change input modes, or move the generator to an input with a different mode selected.
Inverter hums loudly. System display may show messages for high battery voltage, low battery voltage, or backfeed error.	Inverter output is being fed with an external AC source that is out of phase.	Disconnect AC output wires. Turn the inverter off and then on. If the problem clears, reconnect the AC output wires. If the problem recurs when reconnected, an external AC source is connected to the output.
	Inverter has been incorrectly stacked with another unit on the same output. All units come defaulted as master.	Check HUB ports and make certain the master inverter is plugged into port 1. <i>System display only:</i> Check stacking settings in the Inverter Stacking menu. Only one master is allowed per system.
Generator, external fan, etc. fails to start when signal is provided by Aux output.	AUX output is not connected.	Test the generator or device to confirm functionality. Test the appropriate AUX terminals with a DVM. (If the RELAY AUX terminals are in use, test for continuity. If the 12V AUX terminals are in use, test for 12 Vdc.) If the proper results are present when the menu indicates the function is On (and the device still does not work), then there is an external connection problem. If the proper results are not present with the function On , the AUX circuit may be damaged.
	Wrong AUX terminals have been programmed.	<i>System display only:</i> Confirm that the AUX menu that was programmed matches the terminals that are in use. The Auxiliary Output menu programs the 12V AUX terminals. The Auxiliary Relay menu programs the RELAY AUX terminals.
	Wrong AUX terminals are in use.	If generator or external device requires 12 Vdc, confirm the 12V AUX terminals have been connected. The RELAY AUX terminals do not provide voltage.

Table 5 Troubleshooting

Symptom	Possible Cause	Possible Remedy
Advanced Generator Start (AGS) fails to activate when conditions are met (or starts when conditions are not met).	<i>System display only:</i> AGS function does not work if another valid input is present.	Check both inputs for a second AC source (utility grid). If the inverter detects an acceptable AC source, it will not allow AGS . This is true even if it is internally disconnected from the source (due to HBX mode, Mini Grid mode, or similar programming).
	System display is not present.	AGS programming is located in the system display and cannot function if the system display is removed.
	Other AUX functions are in operation.	Gen Alert or another AUX function may try to start or stop the generator using the wrong criteria. Make sure all other AUX functions are disabled.
AGS or Gen Alert functions start the generator, but the inverter does not accept the power and shuts off the generator again.	The inverter's GRID input is in use and the input priority is set to GRID .	If the input priority is set to GRID and the GRID terminals are energized, an automatically controlled generator will shut down. This could indicate that the generator has been wired to the GRID input, or it could indicate that another AC source is active on the GRID input while the generator is using the GEN input. The GEN input must be the only terminals in use when automatically controlling a generator. Either the GRID or GEN input can be used when <i>manually</i> controlling a generator.

Module Select

The GS8048A uses two high-frequency H-Bridge FET modules. The dual design allows half the inverter to shut down for lower idle consumption. Normally this is automatically selected. If one module fails or if troubleshooting is otherwise needed, the module selection can be performed manually. The GS8048A can be directed to use a single, specified module (left or right), or it can be directed to turn on both modules continuously. This procedure should only be performed if directed by OutBack Technical Support.

Although the GS4048A has only a single module, this command is still available. The default setting is **Left**, which is the location of the module. Do not change this setting in the GS4048A.

The Module Select menu options are displayed as part of Table 17, which begins on page 63.

Error Messages

An error is caused by a critical fault. In most cases when this occurs, the unit will shut down. A MATE3-class system display will show an event and a specific error message. This screen is viewed using the Home screen's soft keys. (See the system display literature for more instructions.) One or more messages will display **Y** (yes). If a message says **N** (no), it is not the cause of the error.

NOTE: The Radian has no external indicators. It requires a system display to identify an error. Some errors will reset automatically when the cause is resolved. These are noted.

It is possible to clear errors by resetting the inverter. To reset, turn the inverter off and then on. Other possible steps are shown below. Each should be followed by resetting the inverter.

Table 6 Error Troubleshooting

Message	Causes	Possible Remedy
Low Output Voltage	Inverter's AC regulation cannot be maintained under high load conditions. NOTE: The GS8048A can maintain only 4 kVA on L1 when L2 has loads between 0 and 4 kVA (at 25°C). The opposite is also true. The GS4048A has similar limits at half this wattage.	Check loads and measure current draw. Remove loads as necessary.
AC Output Shorted	Inverter exceeded its maximum surge current due to severe overload.	Check the loads and wiring. This issue is usually the result of a wiring problem (a short), as opposed to a poorly-sized load.
AC Output Backfeed	Usually indicates another AC power source (out of phase with the inverter) was connected to the unit's AC output.	Disconnect the AC OUT wires from the inverter. Check the wires (not the inverter) with an AC voltmeter. If an AC source is present, shut it off.
Stacking Error	Programming problem among stacked units. (Occurs if master inverter was not designated.) Can also occur if AC Output Backfeed occurs.	<ul style="list-style-type: none"> • Check stacking programming and designation of master. (See page 36.) • Check for output backfeed from an external source. Disconnect output if necessary.
Low Battery V³	DC voltage is below the low battery cut-out set point, usually due to battery discharge. It occurs after 5 minutes at this voltage. This error can be triggered by other causes. It can appear along with Low Output Voltage , AC Output Shorted , or AC Output Backfeed .	<ul style="list-style-type: none"> • If this error accompanies other errors, treat those conditions as appropriate. • If it occurs by itself: Recharge the batteries. The error will clear automatically if an AC source is connected and the charger turns on.
High Battery V³	DC voltage exceeded acceptable level. See page 21.	Check the charging source. This problem is usually the result of external charging.
Over Temperature³	Inverter has exceeded its maximum allowed operating temperature. See page 53.	Allow the inverter to remain off to reduce the temperature, or add external cooling.
Comm Fault	The inverter has suffered an internal communication failure.	Unit may be damaged and requires repair.
Loose DC Neg Terminals (L or R)	Loose DC connection on left (L) or right (R) internal power module.	Tighten all DC connections between inverter and battery. If the error is not resolved, unit may be damaged and requires repair.
Battery Voltage Sense	Internal sensing has detected battery voltages below 32 Vdc or above 64 Vdc.	If these readings are not correct, unit may be damaged and requires repair.
AC Relay Fault	AC transfer relay damaged.	Unit may be damaged and requires repair.

³ This error will clear automatically when the cause of the error is resolved. The inverter will begin functioning again when this occurs.
900-0161-01-01 Rev B

Warning Messages

A warning message is caused by a non-critical fault. When this occurs, the unit will not shut down, but a MATE3-class system display will show an event and a specific warning message. This screen is viewed using the Home screen's soft keys. (See the system display literature for more instructions.) One or more messages will display **Y** (yes). If a message says **N** (no), it is not the cause of the warning.

NOTE: The Radian series has no external indicators. It requires a system display to identify a warning.

Some warnings can become errors if left unattended. Frequency and voltage warnings are meant to warn of a problematic AC source. Often the inverter will disconnect from the source. This will occur if the condition lasts longer than the inverter's transfer delay settings. If the inverter disconnects, the warning will display as long as the source is present, accompanied by a disconnect message. (See page 54.)

Warning screens can only display warnings; they cannot clear them. The way to correct the fault may be obvious from the message.

Table 7 Warning Troubleshooting

Message	Definition	Possible Remedy
<i>AC Freq Too High</i>	The AC source is above the upper acceptable frequency limit and prevents connection.	Check the AC source. If it is a generator, reduce its speed.
<i>AC Freq Too Low</i>	The AC source is below the lower acceptable frequency limit and prevents connection.	Check the AC source. If it is a generator, increase its speed.
<i>Voltage Too High</i>	The AC source is above the upper acceptable voltage limit and prevents connection.	Check the AC source. The inverter's acceptance range is adjustable. NOTE: Adjusting the range may accommodate a problematic AC source, but it will not fix it.
<i>Voltage Too Low</i>	The AC source is below the lower acceptable voltage limit and prevents connection.	Check the AC source. Check the AC wiring. The inverter's acceptance range is adjustable. NOTE: Adjusting the range may accommodate a problematic AC source, but it will not fix it.
<i>Input Amps > Max</i>	AC loads are drawing more current from the AC source than allowed by the input setting.	Check the loads. Oversized loads can open circuit breakers. If they exceed the inverter's transfer relay size, the relay can be damaged. This issue is usually the result of a poorly-sized load, as opposed to a wiring problem.
<i>Temp Sensor Bad</i>	An internal inverter temperature sensor may be malfunctioning. One of the three internal sensor meters may give an unusual reading.	In the system display, the three readings are labeled Transformer , Output FETs , and Capacitors . These values are given in degrees Celsius. See next page.
<i>Phase Loss</i>	A slave was ordered to transfer to an AC source by the master, but the AC source is the wrong phase or no AC source is present.	Check the AC voltage on the inverter input terminals. If AC voltage is not present, problem is external. If AC voltage is present, the unit may be damaged and requires repair.

Table 7 Warning Troubleshooting

Message	Definition	Possible Remedy
Fan Failure	The inverter's internal cooling fan is not operating properly. Lack of cooling may result in derated inverter output wattage.	Turn the battery disconnect off, and then on, to determine if the fan self-tests. If it does not, the unit may be damaged and requires repair. NOTE: The system can continue to operate if the inverter can be run at reasonable levels. External cooling may also be applied.
Transformer (in Temps menu)	Displays the ambient temperature around the inverter's transformer.	In a MATE3-class system display, these values are given in degrees Celsius. If any reading does not seem to reflect the inverter's temperature or conditions, the unit may be damaged and requires repair.
Output FETs (in Temps menu)	Displays the temperature of the FETs (Field Effect Transistors) and heat sink.	
Capacitors (in Temps menu)	Displays the temperature of the inverter's ripple capacitors.	

Temperature Events

The temperature sensor readings shown in Table 7 are used to limit the inverter operation in high temperatures. Table 8 shows the effects on the inverter and the temperature used by each sensor to cause the effect.

Table 8 Inverter Temps

Effect	Temperature Reading		
	Transformer	Output FETs	Capacitors
Over Temperature error	>125°C	>80°C	>80°C
Reduced charging or selling	=120°C	=80°C	=80°C
Fan turns on	>60°C	>60°C	>60°C
Fan turns off	<49°C	<49°C	<49°C

GT Warnings

This screen is also available under the **Inverter Warnings** screen. The warnings in Table 9 indicate why a grid-interactive inverter has stopped selling. These warnings are caused when the grid exceeds one of the settings in the **Grid Support** menu. A **GT Warning** may accompany a **Disconnect** message (see Table 10) or a regular warning (see Table 7), depending on conditions.

Table 9 Grid Tie Warnings

Message	Definition
AC Freq Too High	The AC source has exceeded Grid Interface Protection frequency levels.
AC Freq Too Low	The AC source has dropped below Grid Interface Protection frequency levels.
Voltage Too High	The AC source has exceeded Grid Interface Protection voltage levels.
Voltage Too Low	The AC source has dropped below Grid Interface Protection voltage levels.

Disconnect Messages

Disconnect messages explain why the inverter has disconnected from an AC source after previously being connected. The unit returns to inverting mode if turned on. The **Last AC Disconnect** screen is viewed using the **AC INPUT** hot key on a MATE3-class system display. One or more messages will display **Y** (yes). If a message says **N** (no), it is not the cause of the disconnection. The system display may generate a concurrent event and warning message following the disconnection. (See page 52.) If the AC source is removed, the warning will be blank, but the cause of the last disconnection will remain. 

Disconnect messages only display the reason for the disconnection; they cannot correct it. It is usually the result of external conditions, not an inverter fault. If the condition is corrected, the inverter will reconnect. A few settings can be changed to accommodate AC source problems.

The reasons shown in the **Sell Status** menu for ceasing to sell power (see next page) may be the same as disconnect messages. If the **Grid Interface Protection** settings are exceeded (see page 15), the inverter will disconnect from the utility grid.

Table 10 shows the primary seven reasons for disconnection. An eighth field may be visible, but it can feature several different messages which vary with conditions. A list of these messages and their definitions is featured on the OutBack website at www.outbackpower.com.

Table 10 Disconnect Troubleshooting

Message	Definition	Possible Remedy
Frequency Too High	The AC source has exceeded acceptable frequency levels.	Check AC source. If it is a generator, reduce speed.
Frequency Too Low	The AC source has dropped below acceptable frequency levels.	Check AC source. If it is a generator, increase speed.
Voltage > Maximum	The AC source has exceeded acceptable voltage levels.	Check AC source. The inverter's acceptance range is adjustable. NOTE: Adjusting the range may accommodate a problematic AC source, but it will not fix it.
Voltage < Minimum	The AC source has dropped below acceptable voltage levels.	Check AC source. The inverter's acceptance range is adjustable. NOTE: Adjusting the range may accommodate a problematic AC source, but it will not fix it.
Backfeed	Usually indicates that another AC source (out of phase with the inverter) was connected to the AC output. Can also occur if an out-of-phase AC source is connected to the AC input.	Disconnect the AC OUT wires. Check the wires (not the inverter) with an AC voltmeter. If an AC source is present, shut it off. (This is more often accompanied by an AC Output Backfeed error.) Check input source and wiring. This can be caused by a source with phase problems.
Phase Lock	The unit cannot remain in phase with an erratic AC source.	Check AC source. This can be caused by a generator with a poorly regulated output. Some generators perform this way when low on fuel. Use the Generator input mode if necessary. (See page 12.)
Island Detect	The grid seems to be present but normal grid conditions are not detected. This can occur if the Radian's input is powered by another inverter instead of the grid. It may be the result of an open main disconnect.	Check all input disconnects or circuit breakers for an open circuit. Check for any other inverters installed in the system and disable them. This may (rarely) occur with a generator. Use the Generator input mode if necessary. (See page 12.)

Sell Status

Sell Status messages describe conditions relating to the inverter’s grid-interactive mode. This screen is viewed using the Home screen’s soft keys on a MATE3-class system display. (See the system display literature for more instructions.) One or more messages will display **Y** (yes). If a message says **N** (no), it is not the cause of the disconnection.

If the inverter has stopped selling or charging unexpectedly, this screen may identify the reason. More often these messages are used by a normally functioning inverter to identify external conditions that are preventing selling or charging. (If nothing has stopped, the messages will indicate that as well.)

The acceptable limits for AC source voltage and frequency are controlled by the **Grid Interface Protection** settings, which are shown on page 66. If the AC source exceeds these limits, the inverter will stop selling and display the appropriate code. (At the same time it will disconnect from the utility grid, with an appropriate message in Table 10 as shown on page 54.) After the source returns to the acceptable range, the screen will begin its reconnection timer (with a default setting of five minutes). When the timer expires, the inverter will reconnect to the utility grid and begin selling power again.

If the AC source is unstable, it may become unacceptable before the timer expires. This may cause the timer to continually reset. It is possible for brief fluctuations to occur that are too fast to be seen on a DVM. If this happens, the appropriate message will still appear on the system display for a short time to help troubleshoot the problem.

Additionally, undersized wires or bad connections can result in local voltage problems. If a **Voltage Too Low** or **Voltage Too High** message is accompanied by voltage changes that do not appear at the main utility connection, check the wiring.

Table 11 Sell Status Messages

Sell Status	Definition
<i>Selling Disabled</i>	The Grid-Tie Enable command has been set to N (no).
<i>Qualifying Grid</i>	All utility grid conditions are acceptable. The inverter is running a timed test during which it confirms the grid quality. The timer is shown on the screen. At the end of that time, the inverter may be ready to sell.
<i>Frequency Too Low</i>	The utility grid's AC frequency is below the acceptable range for selling.
<i>Frequency Too High</i>	The utility grid's AC frequency is above the acceptable range for selling.
<i>Voltage Too Low</i>	The utility grid's AC voltage is below the acceptable range for selling.
<i>Voltage Too High</i>	The utility grid's AC voltage is above the acceptable range for selling.
<i>Battery < Target</i>	The battery voltage is below the target voltage for that stage (Float, Selling, etc.). No excess energy is available to sell.



Specifications

Electrical Specifications

NOTE: Items qualified with “default” can be manually changed using the system display.

Table 12 Electrical Specifications for Radian Models

Specification	GS8048A	GS4048A
Continuous Output Power at 25°C	8000 VA	4000 VA
Continuous AC Output Current at 25°C	33.3 Aac	16.7 Aac
AC Output Voltage (default)	120/240 Vac	120/240 Vac
AC Output Frequency (default)	60 Hz	60 Hz
AC Output Type	Split-phase	Split-phase
AC Waveform	True Sinewave	True Sinewave
Typical Efficiency	93%	93%
CEC Weighted Efficiency	92.5%	92.5%
Total Harmonic Distortion (maximum)	< 5%	< 5%
Harmonic Distortion (maximum single voltage)	< 2%	< 2%
AC Output Voltage Regulation	± 2%	± 2%
Appliance Protective Class (IEC)	Class I	Class I
Power Factor	-1 to 1	-1 to 1
Inrush Current	None	None
AC Maximum Output Current (1 ms peak)	100 Aac @240 Vac	50 Aac @240 Vac
AC Maximum Output Current (100 ms RMS)	70.7 Aac @240 Vac	35.35 Aac @240 Vac
AC Overload Capability (100 ms surge)	16.97 kVA	8.48 kVA
AC Overload Capability (5 second)	12.0 kVA	6.0 kVA
AC Overload Capability (30 minute)	9.0 kVA	4.5 kVA
AC Maximum Output Fault Current and Duration	109 Aac for 0.364 seconds	54.5 Aac for 0.364 seconds
Power Consumption (idle) – Invert mode, no load	34 watts	34 watts
Power Consumption (idle) – Search mode	10 watts	10 watts
Power Consumption – Off	4 watts	4 watts
AC Input Voltage Range	(L1 or L2) 85 to 140 Vac	(L1 or L2) 85 to 140 Vac
AC Input Frequency Range	54 to 66 Hz (60-Hz setting) 45 to 55 Hz (50-Hz setting)	54 to 66 Hz (60-Hz setting) 45 to 55 Hz (50-Hz setting)
AC Input Current (maximum continuous)	50 Aac	50 Aac
Grid-Interactive Voltage Range (default)	(L1 or L2) 106 to 132 Vac	(L1 or L2) 106 to 132 Vac
Grid-Interactive Frequency Range (default)	59.3 to 60.5 Hz	59.3 to 60.5 Hz
DC Input Voltage (nominal)	48 Vdc	48 Vdc
DC Input Voltage Range	40 to 64 Vdc	40 to 64 Vdc

Specifications

Table 12 Electrical Specifications for Radian Models

Specification	GS8048A	GS4048A
DC Maximum Input Voltage	68 Vdc	68 Vdc
DC Input Power (continuous)	9.5 kVA	4.8 kVA
DC Input Max. Current (continuous full power)	200 Adc	100 Adc
DC Input Maximum Current (surge)	424.2 Adc	212.1 Adc
DC Input Maximum Current (short-circuit)	8975 Adc	4488 Adc
Battery Charger Maximum AC Input	30 Aac at 240 Vac	15 Aac at 240 Vac
Battery Charger Maximum DC Output	115 Adc	57.5 Adc
DC Output Voltage Range (charging)	44 to 68 Vdc	44 to 68 Vdc
Auxiliary Output	0.7 Adc at 12 Vdc	0.7 Adc at 12 Vdc
Auxiliary Relay	10 A at 250 Vac or 30 Vdc	10 A at 250 Vac or 30 Vdc

Mechanical Specifications

Table 13 Mechanical Specifications for Radian Models

Specification	GS8048A	GS4048A
Inverter Dimensions (H x W x D)	28 x 16 x 8.75" (71.1 x 40.6 x 22.2 cm)	28 x 16 x 8.75" (71.1 x 40.6 x 22.2 cm)
Shipping Dimensions (H x W x L)	14.5 x 21 x 34.5" (36.8 x 53.3 x 87.6 cm)	14.5 x 21 x 34.5" (36.8 x 53.3 x 87.6 cm)
Inverter Weight	125 lb (56.8 kg)	82 lb (37.2 kg)
Shipping Weight	140 lb (63.5 kg)	89 lb (40.3 kg)
Accessory Ports	RJ11 (batt temp) and RJ45 (remote)	RJ11 (batt temp) and RJ45 (remote)
Non-volatile Memory	Yes	Yes
Neutral-Ground Bond Switching	No	No
Chassis Type	Vented	Vented

Environmental Specifications

Table 14 Environmental Specifications for Radian Models

Specification	Value
Rated Temperature Range (meets component specifications; however, please note that the inverter output wattage is derated above 25°C)	-4°F to 122°F (-20°C to 50°C)
Operational Temperature Range (functions, but not rated for operation; does not necessarily meet all component specifications)	-40°F to 140°F (-40°C to 60°C)
Storage Temperature Range	-40°F to 140°F (-40°C to 60°C)
IP (Ingress Protection) Rating of Enclosure	IP20
Environmental Category	Indoor unconditioned
Wet Locations Classification	Wet locations: No
Relative Humidity Rating	93%
Pollution Degree Classification	PD 2
Maximum Altitude Rating	6561' (2000 m)
Overvoltage Category (AC Input)	3
Overvoltage Category (DC Input)	1

Temperature Derating

All Radian inverters can deliver their full rated wattage at temperatures up to 25°C (77°F). The maximum wattage is rated less in higher temperatures. Above 25°C, the GS8048A is derated by a factor of 80 VA for every increase of 1°C. The GS4048A is derated by 40 VA per 1°C.

Figure 11 is a graph of wattage over temperature, showing the decrease in rated wattage with increased temperature. The graph ends at 50°C (122°F) because the Radian inverter is not rated for operation above that temperature.

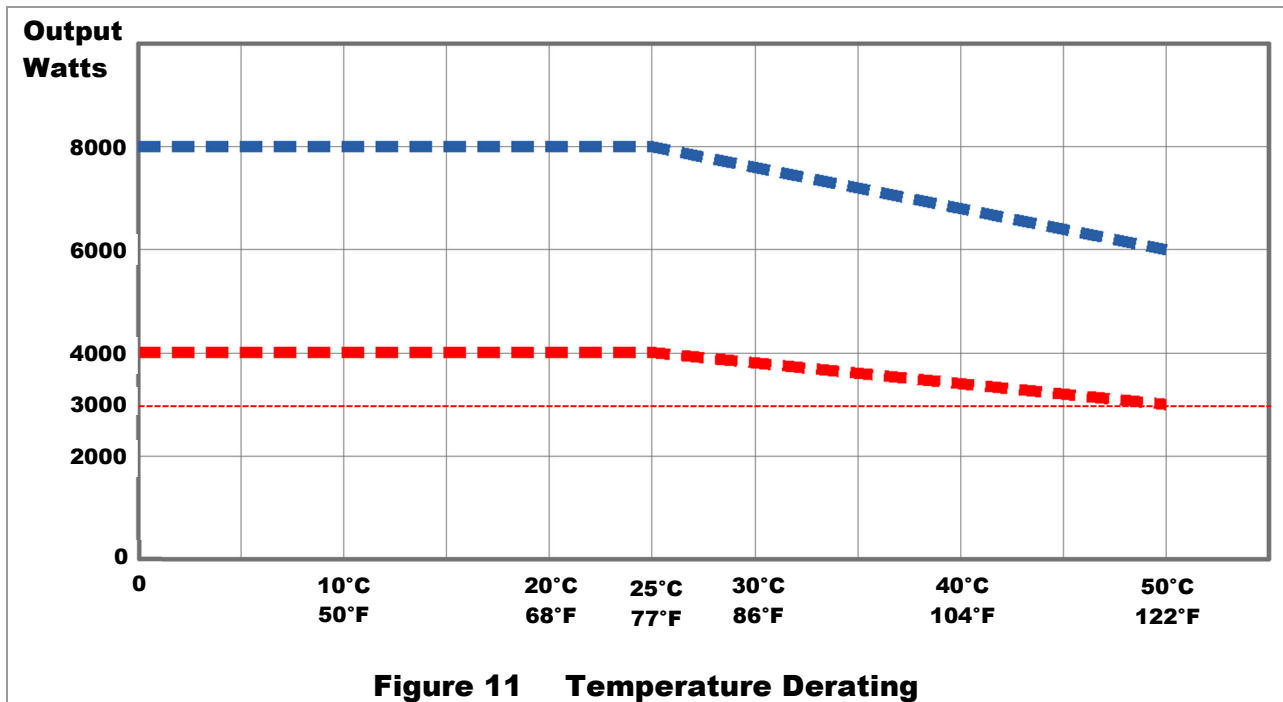

Figure 11 Temperature Derating

Regulatory Specifications

Listings

This product carries a listing report by ETL. It is listed to the following standards:

- UL 1741 — Inverters, Converters, Controllers and Interconnection System Equipment for Use With Distributed Energy Resources (2nd Edition, 1/28/2010 with supplement SA)
- CSA C22.2 — General Use Power Supplies, No. 107.1-01 Issue: 2001/09/01 Ed:3 (R2006)

Certifications

This product has been certified by ETL to meet the following standards:

- UL 1778 — Uninterruptible Power Systems, Annex FF (normative): Backfeed Protection Test
- IEC 62109-1:2010 — Safety of Power Converters for use in Photovoltaic Systems

Compliance

- RoHS: per directive 2011/65/EU
- FCC Part 15.109(G): 2012 Class B
- Hawaiian Electric Companies (HECO) Rule 14H SRD
- California Rule 21 SRD

A complete list of regulatory specifications is available on the *Declaration of Conformity* which is included with the inverter. These include interconnection response times as required by IEEE 1547. They also include manufacturer's stated accuracies and grid support function parameters as required by UL 1741 SA.



NOTE:

The reconnection delay has a default setting of 5 minutes. The grid-interactive default settings are shown in the *Grid Interface Protection Menu* portion of Table 17.

The **Grid Interface Protection** settings are adjustable. However, this is only available to operators with installer-level access. The reason for this limitation is that there are firm rules concerning the acceptable voltage range, frequency range, clearance time during power loss, and reconnect delay when exporting power back to the utility. The rules differ in different locations around the world, although generally it is expected that the settings cannot be altered by the end user. For this reason, the installer password must be changed from the default to get access to these settings. 

Once this password has been changed, the **Grid Interface Protection** settings can be accessed by using the installer password.

See **Grid Tied** mode on page 14 for more information. Also see **Default Settings and Ranges** on page 63.

Limiting Charge Current (Multiple Inverters)

It is not advisable to set **Charger AC Limit** less than 12 Aac in a stacked system. The Power Save function requires the master to activate the slave chargers in sequence only when the charge current exceeds 11 Aac. If the setting is less than 12, **Power Save** will not activate any other chargers. For more information on this function, see the **Power Save** section of the *Radian Series Inverter/Charger Installation Manual*.

When the **Charger AC Limit** setting is 12 Aac or more, other active chargers add the same amount to the total. The total current equals the **Charger AC Limit** setting times the number of active chargers. In some systems, lower currents may be required due to battery bank size or other reasons. To achieve lower currents, chargers can be individually set to **Off** so that the master inverter does not activate them. (The global **Charger Control On** only enables inverters not individually set to **Off**.) Combining the charger limit settings with a reduced number of chargers allows better control over the current.

In Table 15, **Max Charge Adc** shows examples of DC charging values which may be recommended for a battery bank. **Aac** converts these values into AC amperes.

On provides recommendations for the smallest number of chargers. **Set** recommends the **Charger AC Limit** setting. Note that this table specifies the number of chargers to leave **on**. This will achieve the possible closest charging output to the number specified in **Aac** without exceeding it. All other chargers should be turned off using the **Charger Control** menu item. (See the menu tables beginning on page 63 to locate this command in the menu structure.)

The lowest **Adc** figures in this table allow for a single inverter to perform all charging. All other inverters would be turned off. The highest **Adc** figures are for the maximum of ten stacked chargers.

The recommended settings ensure the charging will not exceed a designated current. The amount is likely to be less.

To determine the chargers and settings using Table 15:

1. Obtain the battery bank's maximum charge current (in Adc) from the battery manufacturer.
2. Locate the closest number to this amount (rounded down) on Table 15.
3. Read across to the entry for the appropriate inverter model.
4. Adjust the master inverter's **Charger AC Limit** setting to the designated amount (in Aac).
5. Turn off the chargers for all inverters that exceed the number shown as **On**.

In a stacked system (using the HUB communications manager), chargers on higher-numbered HUB ports should be turned off first. Slave chargers should be turned off before turning off any subphase masters. (See the *Installation Manual* for information on stacking.)

Calculating Limits

If other numbers are needed than those featured in Table 15, the results can be calculated. Do not use the calculations on page 27, due to charger efficiencies and other factors.

Specifications

To calculate the chargers and settings:

1. Look up the values for **A**, **B**, and **C**.

A = the battery bank's maximum charge current (in Adc) from the battery manufacturer.

B = the maximum DC output of the appropriate inverter model. This is taken from Table 16.

C = the maximum AC input of the appropriate inverter model. This is taken from Table 16.

2. Select a value for **D** to be used in the following calculation.

D = the **Charger AC Limit** setting. This value must be 12 or higher. (See page 61.) A higher value uses fewer chargers and turns off all others. A lower value, or 12, leaves more chargers on.

3. Perform the following calculation.

$$\frac{\mathbf{A}}{\mathbf{B}} (\mathbf{C}) \div \mathbf{D} = \mathbf{E}$$

E = the number of chargers to use. This number should be rounded down in all cases.

4. Adjust the master inverter's **Charger AC Limit** setting to equal **D**.
5. Turn off the chargers for all inverters that exceed **E**. In a system stacked on the HUB communications manager, chargers on higher-numbered ports should be turned off first. Chargers should be turned off by setting the **Charger Control** menu item to **Off**. (See the menu tables beginning on page 63 to locate this command in the menu structure.)

Table 15 Chargers On and Current Settings

Max Charge Adc	GS4048A			GS8048A		
	Aac	On	Set	Aac	On	Set
40	10	1	10	10	1	10
60	15	1	15	15	1	15
80	20	1	15	20	1	20
100	26	2	12	26	1	26
120	31	2	15	31	1	30
140	36	3	12	36	2	18
160	41	3	13	41	2	20
180	47	3	15	47	2	23
200	52	4	13	52	2	26
220	57	4	14	57	2	28
240	62	4	15	62	2	30
260	67	5	13	67	3	22
280	73	5	14	73	3	24
300	78	5	15	78	3	26
335	87	6	14	87	3	29
370	96	6	15	96	4	24
400	104	7	14	104	4	26
435	113	8	14	113	4	28
470	122	8	15	122	4	30
500	130	9	14	130	5	26
535	139	9	15	139	5	27
570	148	10	14	148	5	29
600	156	10	15	156	6	26
640	---	---	---	167	6	27
680	---	---	---	177	6	29
720	---	---	---	187	7	26
760	---	---	---	198	7	28
800	---	---	---	208	7	29
840	---	---	---	219	8	27
880	---	---	---	229	8	28
920	---	---	---	240	8	30
960	---	---	---	250	9	27
1000	---	---	---	260	9	28
1050	---	---	---	273	9	30
1100	---	---	---	287	10	28
1150	---	---	---	300	10	30

Table 16 Charge Currents for Calculations

Model	Maximum DC Output (sent to battery)	Maximum AC Input (used from source)
GS4048A	57.5 Adc	15 Aac
GS8048A	115 Adc	30 Aac

Firmware Revision

This manual applies to inverter models GS8048A and GS4048A with Revision 001.006.063 or higher.

Updates to the Radian’s firmware are periodically available. These can be downloaded from the OutBack website **www.outbackpower.com**. The MATE3s system display must be used when upgrading the inverter to firmware revision 001.006.063 or higher.

Default Settings and Ranges

NOTES:

- Certain items are retained at the present setting even when the inverter is reset to factory defaults. These items are noted with the letter “X” in the Item column.
- Certain items, particularly those in the Auxiliary menus, share common set points. If one of these items is changed in a mode menu, all menu items with this set point will show the same change.
- Certain menus are only visible when the installer password is used, particularly the **Grid Interface Protection** menu. These menus are bordered in the table with a double line of this style: **=====**

Table 17 Radian Menu Items

Field	Item	Default	Minimum	Maximum		
INVERTER Hot Key	Inverter Mode	<i>Off</i>	<i>On, Off, or Search</i>			
CHARGER Hot Key	Charger Control	<i>On</i>	<i>On or Off</i>			
AC Input Hot Key	AC Input Mode	<i>Use</i>	<i>Drop or Use</i>			
Search	<i>Sensitivity</i> (see page 23 for increments)	10	0	250		
	<i>Pulse Length</i>	8 AC Cycles	4 AC Cycles	20 AC Cycles		
	<i>Pulse Spacing</i>	60 AC Cycles	4 AC Cycles	120 AC Cycles		
AC Input and Current Limit	<i>Input Priority</i>	<i>Grid</i>	<i>Grid or Gen</i>			
	<i>Grid Input AC Limit</i>	50 Aac	5 Aac	55 Aac		
	<i>Gen Input AC Limit</i>	50 Aac	5 Aac	55 Aac		
	<i>Charger AC Limit</i>	GS8048A GS4048A	30 Aac 15 Aac	0 Aac 0 Aac	30 Aac 15 Aac	
Grid AC Input Mode and Limits	<i>Input Mode</i>	<i>Support</i>	<i>Generator, Support, Grid Tied, UPS, Backup, Mini Grid, GridZero</i>			
	<i>Voltage Limit</i> ⁴	<i>Lower</i>	108 Vac	85 Vac	110 Vac	
		<i>Upper</i>	132 Vac	125 Vac	140 Vac	
	<i>Transfer Delay</i> ⁴		1.0 second	0.12 seconds	4.0 seconds	
	<i>Connect Delay</i> ⁴		0.2 minutes	0.2 minutes	25.0 minutes	
	If <i>Mini Grid</i> mode is selected:	<i>Connect to Grid</i>		48.0 Vdc	44.0 Vdc	64.0 Vdc
		(Connect) <i>Delay</i>		10 minutes	2 minutes	200 minutes
	If <i>Grid Zero</i> mode is selected:	<i>DoD Volts</i>		48.0 Vdc	44.0 Vdc	64.0 Vdc
		<i>DoD Amps</i>	GS8048A	5 Aac	1 Aac	30 Aac
GS4048A			5 Aac	1 Aac	15 Aac	

⁴ These items are not displayed when *Grid Tied* or *Grid Zero* modes are in use.

Specifications

Table 17 Radian Menu Items

Field	Item	Default	Minimum	Maximum	
Gen AC Input Mode and Limits	Input Mode	Generator	Generator, Support, Grid Tied, UPS, Backup, Mini Grid, GridZero		
	Voltage Limit ⁵	Lower	108 Vac	85 Vac	110 Vac
		Upper	140Vac	125 Vac	140 Vac
	Transfer Delay ⁵		1.0 second	0.12 seconds	4.0 seconds
	Connect Delay ⁵		0.5 minutes	0.2 minutes	25.0 minutes
	If Mini Grid mode is selected:	Connect to Grid	48.0 Vdc	44.0 Vdc	64.0 Vdc
		(Connect) Delay	10 minutes	2 minutes	200 minutes
	If Grid Zero mode is selected:	DoD Volts	48.0 Vdc	44.0 Vdc	64.0 Vdc
DoD Amps		GS8048A	5 Aac	1 Aac	30 Aac
		GS4048A	5 Aac	1 Aac	15 Aac
AC Output	Output Voltage	X 120 Vac	100 Vac	130 Vac	
Low Battery	Cut-Out Voltage	42.0 Vdc	36.0 Vdc	48.0 Vdc	
	Cut-In Voltage	50.0 Vdc	40.0 Vdc	56.0 Vdc	
Battery Charger	Absorb Voltage	57.6 Vdc	44.0 Vdc	64.0 Vdc	
	(Absorb) Time	1.0 hours	0.0 hours	24.0 hours	
	Float Voltage	54.4 Vdc	44.0 Vdc	64.0 Vdc	
	(Float) Time	1.0 hours	0.0 hours	24/7	
	Re-Float Voltage	50.0 Vdc	44.0 Vdc	64.0 Vdc	
	Re-Bulk Voltage	49.6 Vdc	44.0 Vdc	64.0 Vdc	
Battery Equalize	Equalize Voltage	58.4 Vdc	44.0 Vdc	68.0 Vdc	
	(Equalize) Time	1.0 hours	0.0 hours	24.0 hours	
Auxiliary Output	Aux Control	Auto	Off, Auto or On		
	Aux Mode	Vent Fan	Load Shed, Gen Alert, Fault, Vent Fan, Cool Fan, DC Divert, GT Limits, Source Status, AC Divert		
	(Load Shed) ON: Batt >	56.0 Vdc	40.0 Vdc	72.0 Vdc	
	(Load Shed ON) Delay	0.5 minutes	0.1 minutes	25.0 minutes	
	(Load Shed) OFF: Batt <	44.0 Vdc	40.0 Vdc	56.0 Vdc	
	(Load Shed OFF) Delay	0.5 minutes	0.1 minutes	25.0 minutes	
	(Gen Alert) ON: Batt <	44.0 Vdc	40.0 Vdc	56.0 Vdc	
	(Gen Alert ON) Delay	0.5 minutes	0.1 minutes	25.0 minutes	
	(Gen Alert) OFF: Batt >	56.0 Vdc	40.0 Vdc	72.0 Vdc	
	(Gen Alert OFF) Delay	0.5 minutes	0.1 minutes	25.0 minutes	
	(Vent Fan) ON: Batt >	56.0 Vdc	40.0 Vdc	72.0 Vdc	
	(Vent Fan) Off Delay	0.5 minutes	0.1 minutes	25.0 minutes	
	(DC Divert) ON: Batt >	56.0 Vdc	40.0 Vdc	72.0 Vdc	
	(DC Divert ON) Delay	0.5 minutes	0.1 minutes	25.0 minutes	
	(DC Divert) OFF: Batt <	44.0 Vdc	40.0 Vdc	56.0 Vdc	
	(DC Divert OFF) Delay	0.5 minutes	0.1 minutes	25.0 minutes	
	(AC Divert) ON: Batt >	56.0 Vdc	40.0 Vdc	72.0 Vdc	
	(AC Divert ON) Delay	0.5 minutes	0.1 minutes	25.0 minutes	
(AC Divert) OFF: Batt <	44.0 Vdc	40.0 Vdc	56.0 Vdc		
(AC Divert OFF) Delay	0.5 minutes	0.1 minutes	25.0 minutes		
Auxiliary Relay	Aux Control	Auto	Off, Auto or On		
	Aux Mode	Gen Alert	Load Shed, Gen Alert, Fault, Vent Fan, Cool Fan, DC Divert, GT Limits, Source Status, AC Divert		
	(Load Shed) ON: Batt >	56.0 Vdc	40.0 Vdc	72.0 Vdc	
	(Load Shed ON) Delay	0.5 minutes	0.1 minutes	25.0 minutes	
	(Load Shed) OFF: Batt <	44.0 Vdc	40.0 Vdc	56.0 Vdc	
	(Load Shed OFF) Delay	0.5 minutes	0.1 minutes	25.0 minutes	

⁵ These items are not displayed when **Grid Tied** or **Grid Zero** modes are in use.

Table 17 Radian Menu Items

Field	Item	Default	Minimum	Maximum				
	(Gen Alert) ON: Batt <	44.0 Vdc	40.0 Vdc	56.0 Vdc				
	(Gen Alert ON) Delay	0.5 minutes	0.1 minutes	25.0 minutes				
	(Gen Alert) OFF: Batt >	56.0 Vdc	40.0 Vdc	72.0 Vdc				
	(Gen Alert OFF) Delay	0.5 minutes	0.1 minutes	25.0 minutes				
	(Vent Fan) ON: Batt >	56.0 Vdc	40.0 Vdc	72.0 Vdc				
	(Vent Fan) Off Delay	0.5 minutes	0.1 minutes	25.0 minutes				
	(DC Divert) ON: Batt >	56.0 Vdc	40.0 Vdc	72.0 Vdc				
	(DC Divert ON) Delay	0.5 minutes	0.1 minutes	25.0 minutes				
	(DC Divert) OFF: Batt <	44.0 Vdc	40.0 Vdc	56.0 Vdc				
	(DC Divert OFF) Delay	0.5 minutes	0.1 minutes	25.0 minutes				
	(AC Divert) ON: Batt >	56.0 Vdc	40.0 Vdc	72.0 Vdc				
	(AC Divert ON) Delay	0.5 minutes	0.1 minutes	25.0 minutes				
	(AC Divert) OFF: Batt <	44.0 Vdc	40.0 Vdc	56.0 Vdc				
	(AC Divert OFF) Delay	0.5 minutes	0.1 minutes	25.0 minutes				
Inverter Stacking	Stack Mode	Master	Master, Slave					
Power Save Ranking	Mode = Master:	Master Power Save Level	0	0	31			
	Mode = Slave:	Slave Power Save Level	1	1	31			
Grid-Tie Sell	Grid-Tie Enable	Y	Y or N					
	Sell Voltage	52.0 Vdc	44.0 Vdc	64.0 Vdc				
Module Control	Module Control	GS8048A	Auto	Auto, Left, Right, Both				
		GS4048A	Left	Auto, Left, Right, Both				
Calibrate	Grid AC Input Voltage	X	0 Vac	-7 Vac	7 Vac			
	Gen AC Input Voltage	X	0 Vac	-7 Vac	7 Vac			
	Output Voltage	X	0 Vac	-7 Vac	7 Vac			
	Battery Voltage	X	0.0 Vdc	-0.8 Vdc	0.8 Vdc			
Grid Interface Protection Menu								
Operating Frequency	Operating Frequency	X	60 Hz	50 Hz, 60 Hz				
Mains Loss	Clearance Time	X	2.0 seconds	1.0 seconds	25.0 seconds			
Sell Current Limit	Maximum Sell Current	GS8048A	X	30 Aac	5 Aac	30 Aac		
		GS4048A	X	15 Aac	5 Aac	15 Aac		
Grid Support Defaults shown are for IEEE 1547 setting	Grid Support Functions		X	N/A	Start Ramp, Freq/Watt, Ramp Rates, Volt/Watt, Fixed PF, Volt/VAr			
	Regulatory Specification		X	IEEE 1547	IEEE 1547, HECO Rule 14, AS4777, ABNT 16149, CA Rule 21			
	Low/High Voltage Ride-Through	OV2	Volts	X	144 Vac	120 Vac	144 Vac	
			Mode	X	Cont.	Cont., Mand., Perm., Mom., Cease		
			Trip	X	0.16 seconds	0.12 seconds	5.00 seconds	
		OV1	Volts	X	132 Vac	120 Vac	140 Vac	
			Mode	X	Cont.	Cont., Mand., Perm., Mom., Cease		
			Trip	X	1 second	1 second	50 seconds	
		UV1	Volts	X	106 Vac	60 Vac	120 Vac	
			Mode	X	Cont.	Cont., Mand., Perm., Mom., Cease		
			Trip	X	2 seconds	1 second	50 seconds	
		UV2	Volts	X	60 Vac	60 Vac	106 Vac	
			Mode	X	Cont.	Cont., Mand., Perm., Mom., Cease		
			Trip	X	11 seconds	1 second	50 seconds	
	UV3	Volts	X	60 Vac	0 Vac	105 Vac		
		Mode	X	Cont.	Cont., Mand., Perm., Mom., Cease			
Trip		X	0.16 seconds	0.12 seconds	21 seconds			

Specifications

Table 17 Radian Menu Items

Field	Item	Default	Minimum	Maximum			
Grid Support (continued)	Low/High Frequency Ride-Through	OF2	Freq.	60.5 Hz	60.1 Hz	66.0 Hz	
			Mode	X	Cont.	Cont., Mand., Perm., Mom., Cease	
			Trip	0.16 seconds	0.12 seconds	1000 seconds	
		OF1	Freq.	60.5 Hz	60.1 Hz	66 Hz	
			Mode	X	Cont.	Cont., Mand., Perm., Mom., Cease	
			Trip	300 seconds	4 seconds	1000 seconds	
		UF1	Freq.	59.3 Hz	50.0 Hz	59.9 Hz	
			Mode	X	Cont.	Cont., Mand., Perm., Mom., Cease	
			Trip	300 seconds	4 seconds	1000 seconds	
		UF2	Freq.	59.3 Hz	50.0 Hz	59.9 Hz	
			Mode	X	Cont.	Cont., Mand., Perm., Mom., Cease	
			Trip	0.16 seconds	0.12 seconds	1000 seconds	
	Fixed Power Factor	Set Input PF		X	1.00	0.80	1.00
		PF Current			Lead	Lead or Lag	
	Ramping	Start Ramp		X	250% /min	6% /min	250% /min
		Normal Ramp			250% /min	6% /min	250% /min
	Frequency Watt	Start Freq	High	X	60.50 Hz	60.05 Hz	65.00 Hz
			Low		59.75 Hz	55.00 Hz	59.95 Hz
		Gradient	High	X	250% / Hz	5% / Hz	250% / Hz
			Low		133% / Hz	5% / Hz	250% / Hz
		Re-Start Freq	High	X	60.50 Hz	60.000 Hz	64.90 Hz
			Low		59.85 Hz	55.10 Hz	60.00 Hz
	Re-Start Period			1 minute	0 minutes	30 minutes	
	Volt Watt	Start Volt	High	X	127 Vac	123 Vac	132 Vac
			Low		113 Vac	108 Vac	117 Vac
		Gradient	High	X	10% / Vac	3% / Vac	100% / Vac
			Low		10% / Vac	3% / Vac	100% / Vac
		Re-Start Volt	High	X	125 Vac	122 Vac	130 Vac
	Low			114 Vac	110 Vac	118 Vac	
	Re-Start Period		X	1 minute	0 minutes	30 minutes	
	Volt/VAr	V1	X	106 Vac	98 Vac	124 Vac	
		V2	X	114 Vac	106 Vac	126 Vac	
		V3	X	126 Vac	114 Vac	132 Vac	
		V4	X	132 Vac	116 Vac	142 Vac	
		Source PF at V1	X	0.90	0.80	1.00	
		Sink PF at V4	X	0.90	0.80	1.00	
	Reconnect Parameters	Reconnect Delay	X	300 seconds	0 seconds	600 seconds	
		High VAC Connect	X	132 Vac	115 Vac	144 Vac	
		Low VAC Connect	X	106 Vac	96 Vac	125 Vac	
		High Freq Connect	X	60.5 Hz	60.5 Hz	66.0 Hz	
		Low Freq Connect	X	59.3 Hz	50.0 Hz	59.9 Hz	
	Multi-Function Parameters			These selections are inoperative			
	Upload Grid Protection — no settings; used for Grid Support firmware installation 						

Definitions

The following is a list of initials, terms, and definitions used in conjunction with this product.

Table 18 Terms and Definitions

Term	Definition
12V AUX	Auxiliary connection that supplies 12 Vdc to control external devices.
AIC	Ampere Interrupting Capacity; the rated current a circuit breaker can interrupt without damage
AGS	Advanced Generator Start
Communications manager	Multi-port device such as the OutBack HUB10.3, used for connecting multiple OutBack devices on a single remote display; essential for stacking inverters
CSA	Canadian Standards Association; establishes Canadian national standards and the Canadian Electrical Code, including C22.1 and C22.2
ETL	Electrical Testing Laboratories; short for the company ETL Semko (Intertek); refers to a certification issued by ETL to OutBack products indicating that they meet certain UL standards
FCC	Federal Communications Commission
GND	Ground; a permanent conductive connection to earth for safety reasons; also known as Chassis Ground, Protective Earth, PE, Grounding Electrode Conductor, and GEC
Grid-interactive, grid-intertie, grid-tie	Utility grid power is available for use and the inverter is a model capable of returning (selling) electricity back to the utility grid
HBX	High Battery Transfer; a function of the remote system display
GSLC	GS Load Center; the wiring box for the Radian (GS) inverter
IEEE	Institute of Electrical and Electronics Engineers; refers to a series of standards and practices for the testing of electrical products
Invert, inverting	The act of converting DC voltage to AC voltage for load use or other applications
LBCO	Low Battery Cut-Out; set point at which the inverter shuts down due to low voltage
Master	An inverter which provides the primary output phase of a stacked system; other stacked inverters base their output and on/off state on the master
NEU	AC Neutral; also known as Common
Neutral-to-ground bond	A mechanical connection between the AC neutral (Common) bus and the ground (PE) bus; this bond makes the AC neutral safe to handle
Off-grid	Utility grid power <i>is not</i> available for use
PV	Photovoltaic
RE	Renewable Energy
RELAY AUX	Auxiliary connection that uses switch (relay) contacts to control external devices.
RTS	Remote Temperature Sensor; accessory that measures battery temperature for charging
Slave	An inverter which adds additional power to the master or subphase master in a stacked system; a slave does not provide an output of its own
Split-phase	A type of utility electrical system with two "hot" lines 180° out of phase, common in North America; each line typically carries 120 Vac (or the nominal line voltage) with respect to neutral and 240 Vac with respect to each other
System display	Remote interface device (such as the MATE3s), used for monitoring, programming and communicating with the inverter; also called "remote system display"
Three-phase, 3-phase	A type of utility electrical system with three "hot" lines, each 120° out of phase; each carries the nominal line voltage with respect to neutral; each carries voltage with respect to each other equaling the line voltage multiplied by 1.732
UL	Underwriters Laboratories; refers to a set of safety standards governing electrical products
Utility grid	The electrical service and infrastructure supported by the electrical or utility company; also called "mains", "utility service", or "grid"



Index

1

12V AUX.....39

A

Absorption Stage.....29
AC Input9, 24
AC Source Acceptance25
AC Test Points45
Advanced Generator Start (AGS)40, 50
Audience7
AUX39, 68
AUX Functions
 Cool Fan40
 Diversion Control41
 Fault40
 GenAlert.....40
 GT Limits.....41
 LoadShed.....39
 Source Status41
 Summary Table.....42
 Vent Fan40
AXS Port.....9, 10

B

Backup Mode16
Batteries21, 22
Battery Charging27
 Current27
 Graphs28, 32, 33
 Steps.....28
Battery Voltage.....44
Bulk Stage29

C

Caution Symbol7
Charging
 Absorption Stage29
 Bulk29
 Current27
 Equalization34

Float.....30
Multiple Inverters27, 61
New Bulk32
None29
Re-Bulk.....31, 33
Refloat30
Re-Float.....32
Silent.....30
Steps.....29, 31
Charging Current28, 61
Communications Manager68
Cool Fan.....40
CSA.....9, 60

D

Default Settings.....63
Definitions68
Design21
Disconnect54
Diversion Control41

E

Equalization34
Errors51

F

FCC.....60
Features.....9
Firmware2, 10, 63
Float30
Float Stage.....30
Frequency15, 22
Functions9
 AC Input Limit24
 AC Transfer26
 Grid Support37
 Inverting.....21
 LBCO22
 Offset36
 Search23

Index

G

GenAlert	40
Generator	
Acceptance	12, 25
Sizing	26
Starting.....	40, 49, 50
Generator Mode	12
GIP File	15, 37
Grid Acceptance.....	25
Grid Interface Protection	15, 25, 60, 66
Grid Support.....	9, 15, 37
Grid Tie Warning	53
Grid Tied.....	25, 53, 55
Grid Use Time	16
Grid-Interactive.....	14, 68
Grid-Tied Mode	14
GridZero Mode	18
GSLC.....	68
GT Limits	41
GT Warnings	53

H

High Battery Cut-Out.....	22
High Battery Transfer (HBX)	16
HUB10.3.....	9

I

Important Symbol	7
Input Modes.....	9, 11, 24, 36
Summary Table.....	19
Input Priorities	24
Inverting.....	21

L

Load Grid Transfer	16
LoadShed	39
Low Battery Cut-In.....	22
Low Battery Cut-Out (LBCO)	22

M

MATE3s, MATE3-class	10, 43, 45
Metering	43
Mini Grid Mode	16
Modes.....	9
Backup	16
Generator.....	12
Grid Tied	14, 25, 55
GridZero.....	18

Mini Grid	16
Summary Table	19
Support.....	13
UPS	16
Module	21, 50

N

Note Symbol	7
-------------------	---

O

Offset.....	36
OPTICS RE.....	9, 10
Output	
Frequency.....	15, 22
Voltage	22

R

Re-Bulk	31, 33
Re-Float	32
Regulatory.....	60
Relay AUX	39
Remote System Display.....	68
Remote Temperature Sensor (RTS).....	34
Revision	2, 10, 63

S

Safety	7
Screens	43
Search.....	23
Sell Status.....	55
Settings	63
Silent	
Charging	30
Slope	35
Source Status	41
Specifications	
Electrical	57
Environmental.....	59
Mechanical	58
Regulatory	60
Stacking	61
Charging	27
Support Mode	13
Switch.....	10
Symbols Used.....	7
System Display	10, 43, 45, 68

T

Temperature.....	53, 59
Temperature Compensation	34
Terms and Definitions	68
Test Points	45
Timers	
Absorption.....	29
Equalize	34
Float	31
Transfer Relay.....	24, 26
Troubleshooting.....	45
Disconnect Messages.....	54
Error Messages.....	51
Self Status Messages	55
Warning Messages	52

U

UL 1741.....	9, 60
Updating Firmware.....	63
UPS Mode.....	16
Utility Grid	68

V

Vent Fan Control.....	40
-----------------------	----

W

Warning Symbol.....	7
Warnings (General).....	52
Warnings (Grid Tie).....	53
Website	63



Masters of the Off-Grid.™ First Choice for the New Grid.

Corporate Headquarters
17825 – 59th Avenue N.E.
Suite B
Arlington, WA 98223 USA
+1.360.435.6030

European Office
Hansastraße 8
D-91126
Schwabach, Germany
+49.9122.79889.0